

# IGNITION MODULE

FOR USE WITH

**2013-2015 Triumph Daytona 675**

**Installation Instructions**

**[POWER  
COMMANDER V]**

## **PARTS LIST**

- 1 Ignition Module
- 1 Installation Guide
- 2 Velcro strips
- 1 Alcohol swab
- 1 CAN link cable
- 1 USB cable



**THE VEHICLE'S IGNITION MUST BE TURNED OFF  
DURING THIS INSTALLATION!  
BEFORE THIS MODULE CAN BE USED THE  
POWER COMMANDER 5 MAY NEED TO BE UPDATED.  
(SEE INCLUDED INSTRUCTIONS.)**

**PLEASE READ ALL DIRECTIONS BEFORE STARTING INSTALLATION**

***Dynojet***

2191 Mendenhall Drive North Las Vegas, NV 89081 (800) 992-4993 [www.powercommander.com](http://www.powercommander.com)

# IGNITION MODULE V INPUT ACCESSORY GUIDE

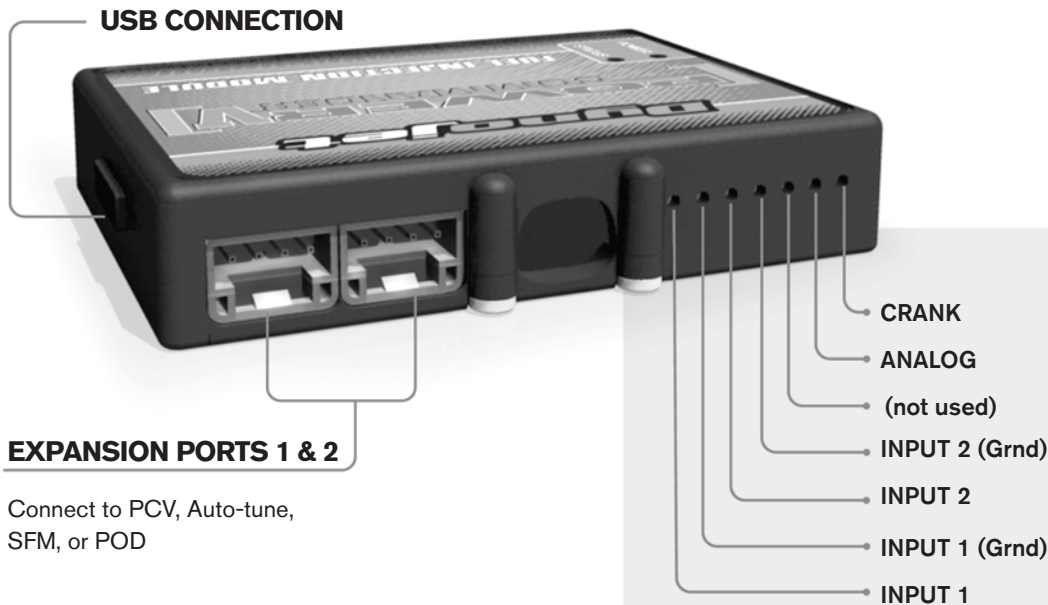

Connect to PCV, Auto-tune, SFM, or POD

## Wire connections:

To input wires into the IM first remove the rubber plug on the backside of the unit and loosen the screw for the corresponding input. Using a 22-24 gauge wire strip about 10mm from its end. Push the wire into the hole of the IM until it stops and then tighten the screw. Make sure to reinstall the rubber plug.

NOTE: If you tin the wires with solder it will make inserting them easier.

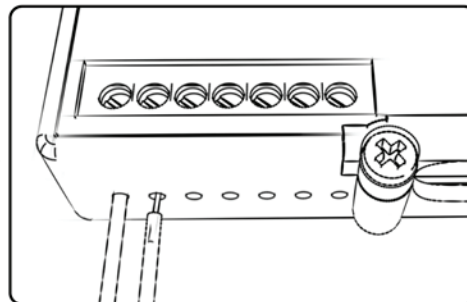

## ACCESSORY INPUTS

- Speed -** The Speed Limiter feature uses Switch Input #1 or #2. This feature gives the ability to activate a limiter based on vehicle speed. This is intended to be used as a pit lane speed limiter. You can use any OPEN / CLOSED type switch to activate this feature. The feature is configured to Switch Input #1 by default.
- Launch -** The Launch Control feature also uses Switch Input #1 or #2. This feature is intended to be used as a two stage rev-limiter. You can set a target RPM to limit the bike to when the clutch lever is activated. Once the clutch lever is released full RPM can be achieved. This requires a wire be connected to the grounding side of the clutch switch and the other end into this input. The feature is configured to Switch Input #2 by default.
- Grounds -** These are constant digital grounds. If you are using the Secondary Fuel Module accessory, the unterminated BLACK/WHITE wire from the SFM would go to either one of these inputs.
- Analog -** Not currently used - updates to follow
- Crank -** If you are using the Secondary Fuel Module accessory, the unterminated WHITE wire from the SFM would go here.

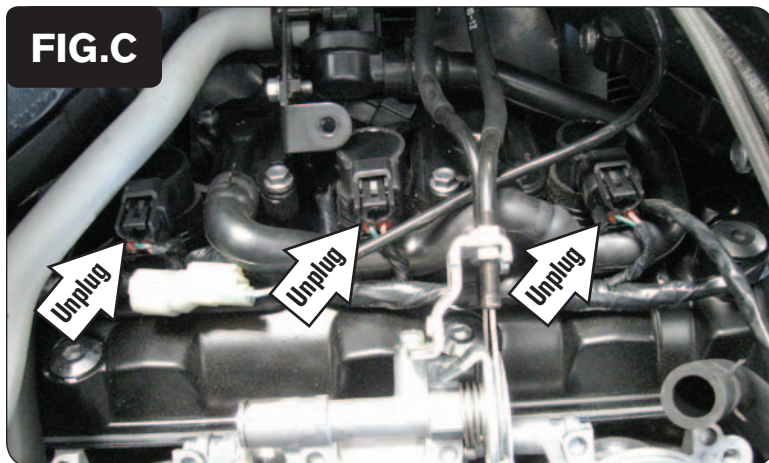
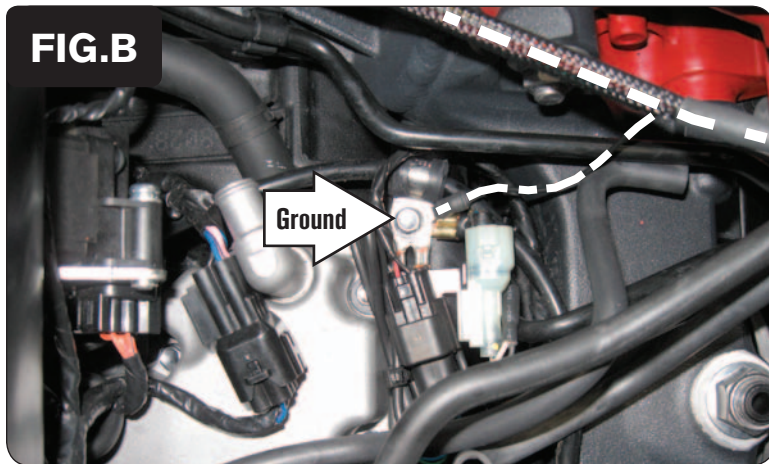

- 1 Remove the seat, fuel tank, airbox, and the bodywork surrounding the tail.
- 2 Using the supplied Velcro, secure the IM under the PCV module in the tail section (Fig. A).

*Use the supplied alcohol swab to clean the surface area prior to applying the Velcro.*

- 3 Connect the CAN link cable to an expansion port on the PCV and the other end to an expansion port on the IM.

*It doesn't matter which ports you use.*

*Older Ignition Modules with a serial number beginning with 14 or less might also require a CAN termination plug to be installed in an empty port. Newer Ignition Modules with a serial number starting with 15 or higher do NOT require CAN termination plugs.*

- 4 Connect the WHITE and BLACK/WHITE wires from the IM to the crank input and digital ground input on the PCV module. (See page 5 for further details.)
- 5 Route the wiring harness from the Ignition Module down the right hand side of the bike, just inside the frame rail (Fig. A).
- 6 Secure the ground wire of the Ignition Module with the small ring terminal to the same common ground as the PCV on top of the engine case (Fig. B).
- 7 Continue routing the IM wiring harness inside of the right side frame rail towards the Ignition Coil sticks at the top of the engine's valve cover.

- 8 Unplug the stock wiring harness connector from each coil stick (Fig. C).

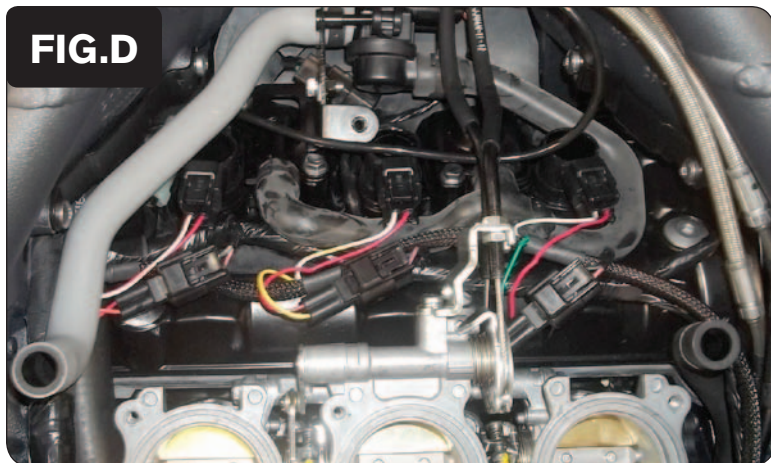

- 9 Plug the Ignition Module connectors in-line of the coil sticks and the stock wiring harness connectors (Fig. D).

*The pair of IM connectors with ORANGE colored wires go in-line with the cylinder #1 (left most) ignition coil.*

*The pair of IM connectors with YELLOW colored wires go in-line with the cylinder #2 (center) ignition coil.*

*The pair of IM connectors with GREEN colored wires go in-line with the cylinder #3 (right most) ignition coil.*

- 10 Make sure the wiring is free and clear of any hot or moving parts.

- 11 Reinstall the airbox, fuel tank, bodywork, and seat.

### **\*IMPORTANT\***

Dynojet has noticed a high level of inconsistency from bike to bike of this model's Ignition Coil wire polarity. When installing the stock coil stick connector to the Ignition Module coil input connector, make sure that the stock BROWN/PINK wires are aligned and mated with the RED wires of the Ignition Module wiring harness. If not, the pins on the 3 input connectors of the Ignition Module wiring harness may need to be swapped around. Use the following instructions to remove these pins from the connectors and insert them into the correct locations, if necessary.

- a.) Use a small pic or scribe to pry out the yellow retaining clip inside of the connector while being careful not to damage the connector.

- b.) Once the retainer is removed, use your pic or scribe to push the locking tab upward, while simultaneously pulling the wire and pin out of the back of the connector.

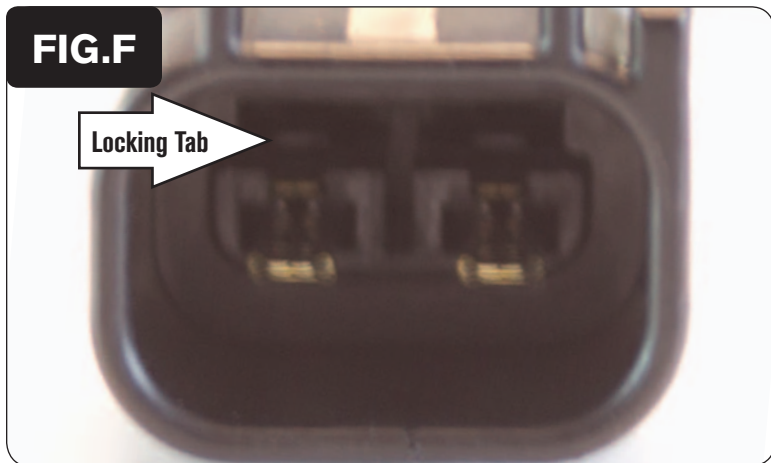

**PCV**

**Ignition Module**

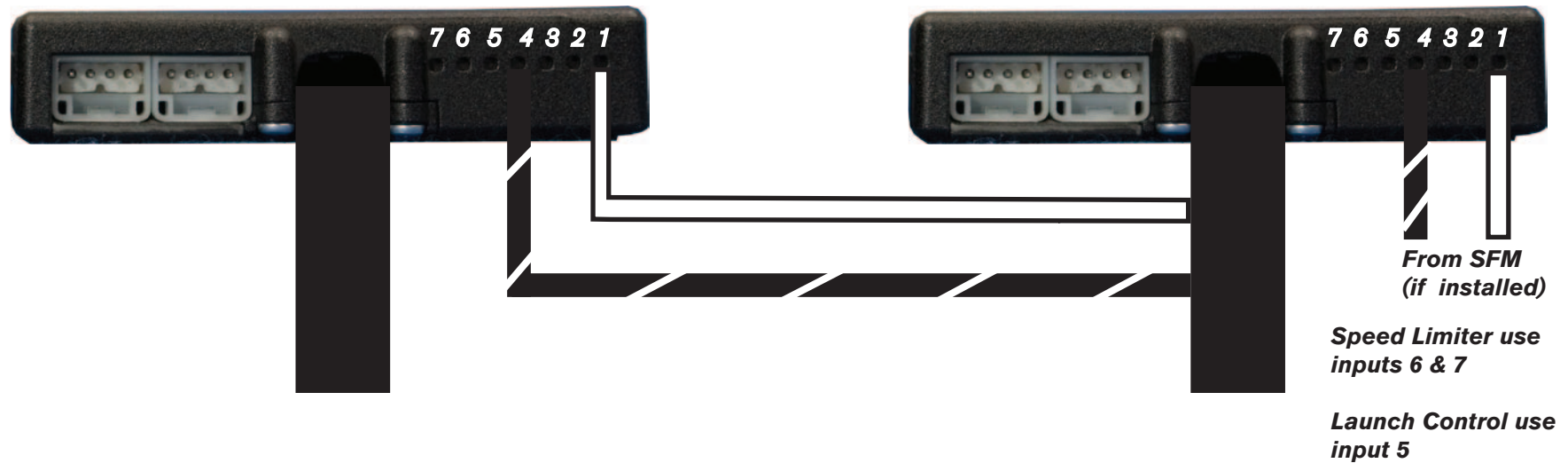

#### **Connecting the Ignition Module to the PCV:**

- The unterminated WHITE and the BLACK/WHITE wires of the Ignition Module wiring harness **MUST** be connected to the PCV for the device to work.
- Connect the WHITE wire from the Ignition Module to the #1 input position of the PCV. Connect the BLACK/WHITE wire to the #4 input position of the PCV. The BLACK/WHITE wire can also be connected to the #6 input position of the PCV, if necessary. If both #4 and #6 inputs are already occupied, you can splice the BLACK/WHITE wire to the wire that is currently occupying either of these inputs.

*To make it easier to insert the wires into the wire terminal strip you might first pierce through the foam seal with a pin or pointed instrument.*

- If you are also using the SFM (Secondary Fuel Module), then you will need to connect the WHITE and BLACK/WHITE wires from the SFM into the Ignition Module. Connect the WHITE wire from the SFM to the #1 input position of the Ignition Module. Connect the BLACK/WHITE wire to the #4 input position of the Ignition Module. The BLACK/WHITE wire can also be connected to the #6 input position of the Ignition Module, if necessary.

#### **Adding the Ignition Module to the PCV network:**

- First download and install the latest version of the PCV Control Center Software (which is version 1.0.6.4.) from the PCV - Downloads page of [www.powercommander.com](http://www.powercommander.com).
- To use the Ignition Module you may need to update your firmware in the PCV (and SFM if being used). Make sure the PCV, SFM, and Ignition Module are all updated to PCV firmware version 0.1.10.6 or newer. Go to View -> Device Information in the software to see the current versions. If you need to update the firmware, go to Power Commander Tools -> Update Firmware. The latest version of the PCV firmware and software can be found on the PCV - Downloads page of [www.powercommander.com](http://www.powercommander.com).
- Connect a USB cable to the PCV and another USB cable to the Ignition Module. The software will ask you to add the Ignition Module to the network. Click OK. Go to Power Commander Tools -> Manage Network and click on Sync Devices Utility. Follow the on screen instructions.