



YOSHIMURA

RESEARCH & DEVELOPMENT OF AMERICA, INC.

5420 DANIELS STREET STE A, CHINO CA., 91710 · (800) 634-9166 · (909) 628-4722 · FAX (909) 591-2198

www.yoshimura-rd.com

Street Series

Qualified Manufacturer Declared "Replacement Part"

2006~2013

Yamaha FZ1

1321272 (CF/CF)

1321275 (SS/SS)

TRC Stainless Steel Slip-On

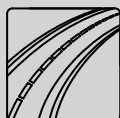

All Street Series systems are:

- Slip-on/Bolt-on applications that do not require tampering with the vehicle's emissions control system.
- CARB/EPA tail-pipe emissions compliant.
- Marked with appropriate EPA noise labels.
- Not tested for EPA new vehicle noise compliance.

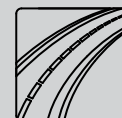

✘ You must know how to remove and replace your stock exhaust in order to install this product otherwise have it installed by a professional mechanic. Keep all stock parts from your existing system as some components may be necessary to install your new Yoshimura exhaust depending on the application. Read through all instructions before beginning installation. Exhaust system can be extremely hot. Let motorcycle cool down before beginning installation. Always wear hand and eye protection and take precautionary measures to avoid injury. ✘

NOTE: IN THE STATE OF CALIFORNIA, IT IS ILLEGAL TO MODIFY THE EMISSION CONTROL SYSTEM, WHICH INCLUDES THE CARBURETORS OF ANY VEHICLE.

Caution: Exhaust system can be extremely hot. Let motorcycle cool down before beginning installation.

Note: Read through all instructions before beginning installation.

Tools Needed:

11mm, 12mm, and 14mm sockets
3/8" ratchet and extension
Torque wrench
8mm and 10mm wrench
5mm Allen wrench

Installation Steps:

1. Place motorcycle on it's centerstand.
2. Remove passenger and rider seats.
3. Carefully remove the rubber stopper from the centerstand and install it onto the Yoshimura tailpipe (see Fig 1 and Fig 2).

**** NOTE:** When installing the rubber stopper the use any type of lubricant will make the installation of the stopper easier.

4. Locate and remove the cover shielding the exhaust valve by removing the two 5mm Allen head bolts (see Fig 3).
5. Loosen and remove both cables from the exhaust valve by loosening the lock nuts (see Fig 4).

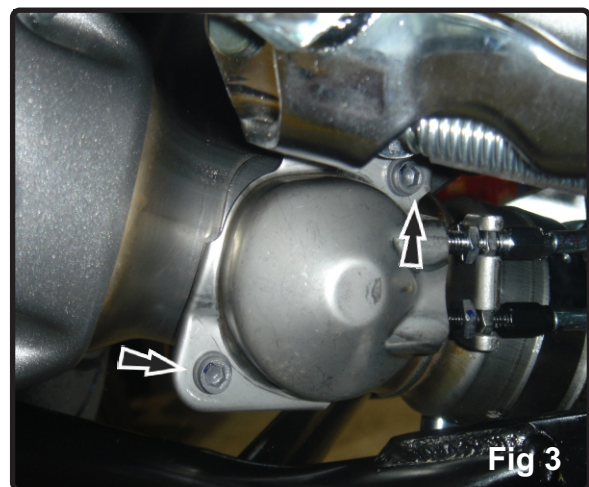
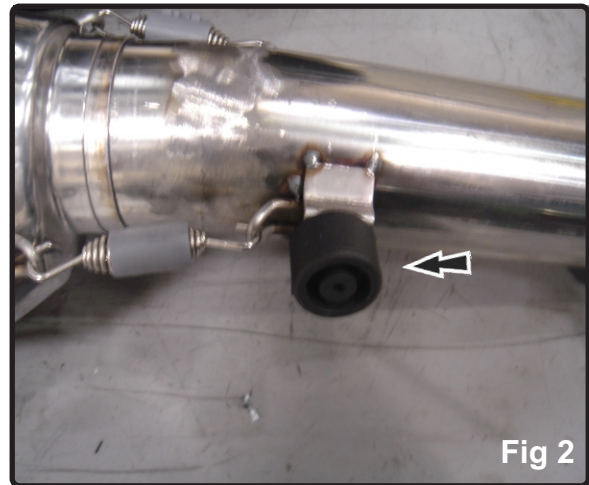

6. Locate the exhaust valve controller at the rear of the fuel tank and remove the exhaust valve controller by removing the one nut holding it in place. Remove the shield and cables from the exhaust controller. Remove the exhaust valve cables from the motorcycle. Reinstall the shield and exhaust valve controller back into the stock location (see Fig 5).

NOTE: Do not disconnect any electrical wires from the exhaust valve controller. The exhaust valve controller must remain plugged in electrically. Remove the exhaust valve cables only.

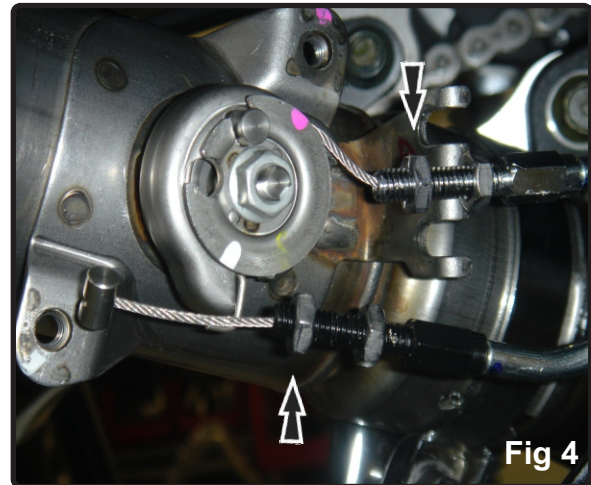

7. Loosen lower stock muffler clamp (see Fig 6).
8. Remove the stock upper muffler mounting bolt and remove stock muffler (see Fig 7).
9. Install exhaust clamp heatshield into exhaust clamp. Install exhaust clamp onto Yoshimura muffler.
10. Slide supplied exhaust clamp over the end of the tailpipe.
11. Install Yoshimura muffler and tailpipe onto the stock header and using the stock and supplied hardware, Torque the muffler mounting bolt to 2.5kg-m (18 lb-ft) (see Fig 8).
12. Torque Yoshimura's exhaust clamp to 1.25 kg-m (9 lb-ft) (see Fig 9).

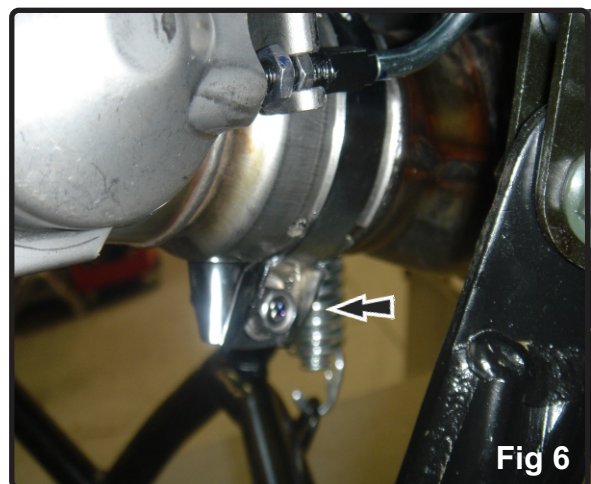

13. Before starting motorcycle, check for proper clearance between new exhaust system and motorcycle (i.e. radiator, oil pan, swing-arm, etc.). If any problem is found, please carefully follow through the installation steps again. If problem still persists, please call Yoshimura technical department at (800)634-9166 / in CA (909)628-4722.

Note: After starting motorcycle, it is normal for new exhaust system to smoke until oil residue burns off.

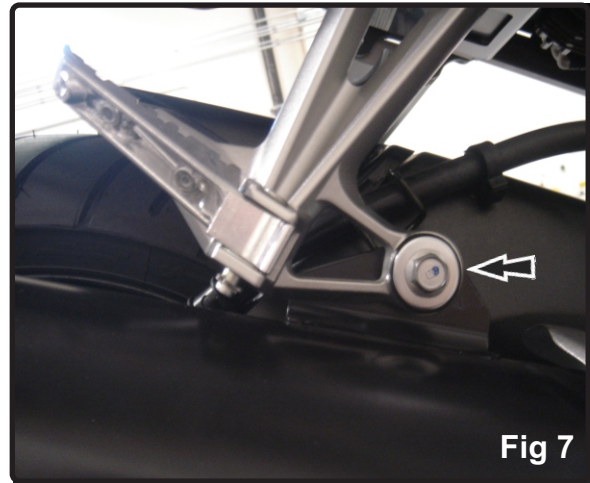

Fig 7



Fig 8

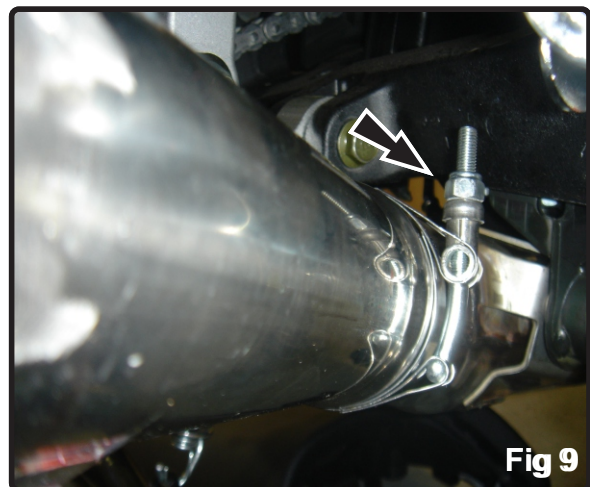
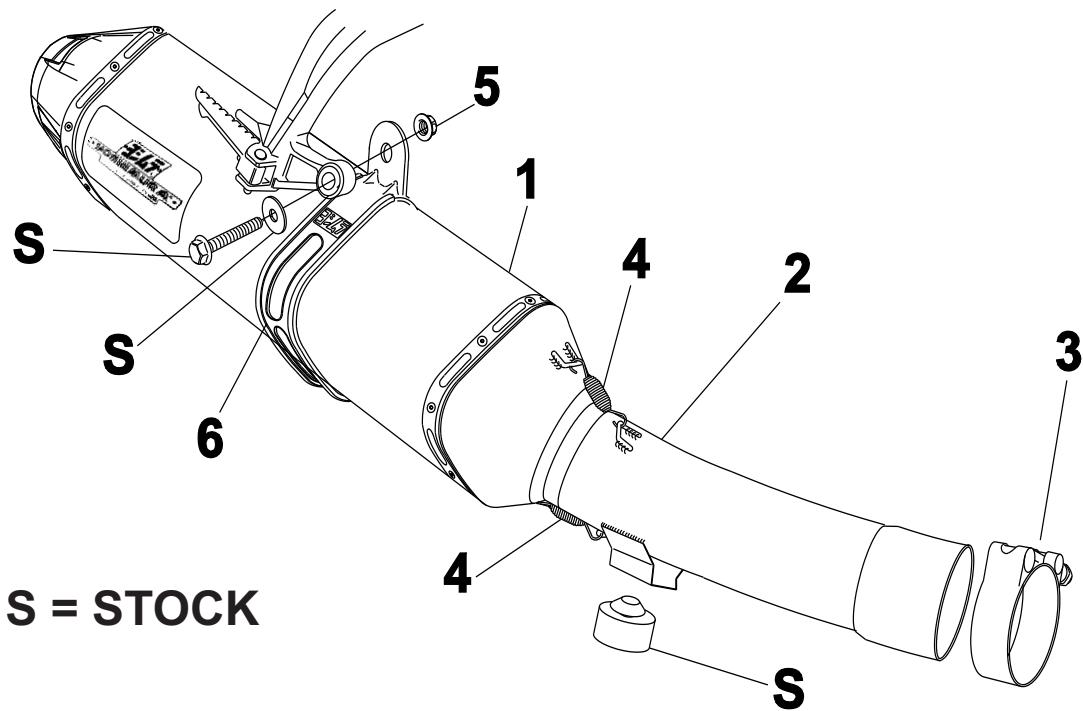

Fig 9

#132127 (2,5,7)



Parts Diagram

NO.	DESCRIPTION	QTY	PART #
1	Yoshimura TRC Muffler Carbon Fiber Sleeve Stainless Steel Sleeve Titanium Sleeve	1	CRTRC126W SRTRC126W TRTRC126W
2	Yoshimura Tailpipe	1	1321-435
3	Clamp	1	20069
4	Medium Exhaust Springs	2	RACE-SPS-1
5	10mm Nut	1	10MMFNUT
6	Exhaust Pipe Clamp Clamp for Titanium and Stainless Clamp for Carbon Fiber	1	CTS105X CTS105
**	Slotted Heatsheid TRC	1	HT SHLDTRS
**	Yoshimura Spring Puller Tool	1	ST-200
**	Yoshimura Vinyl Sticker	2	17028-BLK