



Installation instructions

Akrapovič Exhaust Systems
Racing&Evolution
for the
Aprilia RSV4
Aprilia Tuono V4



502251

www.akrapovic.com

Congratulations on purchasing an Akrapovič exhaust system. Please read the entire installation manual prior to undertaking any activities related to installation of your new Akrapovič exhaust system. In case you do not fully understand the manual or any of its parts, please contact your authorized dealer!

This product should be installed by someone with sufficient knowledge of exhaust systems and their installation, and appropriate hand or power tools. If you are not qualified for this work, please utilize a certified mechanic for installation. By installing Your Akrapovič exhaust system, you indicate that you have read the installation manual in its entirety and you agree with the terms stated herein.

It is your responsibility to follow all installation instruction guidelines supplied with the Akrapovič exhaust system and undertake all necessary safety precautions. Akrapovič d.d. assumes no responsibility for damages occurring from misuse, abuse, improper installation, improper operation, lack of responsible care, or all previously stated reasons resulting from incompatibility with other manufacturer's products and/or systems.

IMPORTANT INFORMATION

Exclusion of Certain Liability

1. The manufacturer, importer or dealer shall not be liable for any incidental damage including personal injury or any other damages caused by improper installation or operation of the Akrapovič exhaust system. When installing the Akrapovič exhaust system be careful that the exhaust system does not touch other parts sensitive to high temperature.
2. Akrapovič makes no representation or warranties with regard to damage caused by the improper installation, use and maintenance of the Akrapovič exhaust system. The warranty is limited to defects recognized by our technical department and due to normal use, and excludes items subject to normal wear (gaskets and damping wool). The guarantee is void in case of accident, modification, improper or competition use.
3. Do not attempt to install the Akrapovič exhaust system on a vehicle model for which it was not made or tested by Akrapovič.
4. When the exhaust system gets very hot during operation, be careful not to burn yourself on the exhaust system or parts which are in direct contact with it, even when the engine is not running. Also protect other people, especially children, from the injuries mentioned above.
5. In some cases Akrapovič exhaust system kits contain chemical products (ceramic anti-seizing grease; bolt sealant). Handle with care, do not inhale or swallow. Avoid excessive contact with skin, eyes or mucous membranes. Keep out of reach of children.
6. Technical specifications of Akrapovič exhaust systems and related products are subject to change without notice.
7. Before removing the original exhaust system from your vehicle, please compare the parts you received with the list of materials provided in the installation manual in order to assure that you have all the parts necessary for the installation of your new Akrapovič exhaust system.
8. Although this manual consists of instructions for installation in written form, as well as photographs and pictures representing individual steps of the installation, please note that the photographs and pictures are symbolic and are intended for representation of general overview only. The photographs and pictures contained herein should serve as a guideline only and actual installation of the exhaust system may not correspond with the photographs and pictures entirely.
9. The process of uninstalling the original exhaust system may vary depending on the existing exhaust system. Please follow the original exhaust system manufacturer's instructions for uninstalling the original exhaust system.

Trademarks

The Akrapovič Exhaust System Technology logo is a registered trademark of Akrapovič d.d.

Akrapovič website

Information about Akrapovič exhaust systems and related products is available on the Akrapovič website at: <http://www.akrapovic.com/>

Copyright

No part of the Akrapovič exhaust system or its documentation may be reproduced or distributed in any form or by any means without the prior written authorization of the Akrapovič company.

© Akrapovič, d.d. All rights reserved.

Symbols

The following symbols are used throughout these installation instructions:



TOOLS REQUIRED



TIGHTENING TORQUE



INSTALLATION TIP



CAUTION OR WARNING



USE BOLT SEALANT; Apply 3 to 4 small drops of bolt sealant onto the cleaned and degreased threads before tightening the bolts. **WARNING! Avoid contact with skin, eyes and mucous membranes. Do not inhale fumes. Keep out of reach of children.**



USE ANTI-SEIZE LEAD-FREE COPPER PASTE (black tube); Provides trouble-free and long-lasting protection against seizing, corrosion and rusting of bolts, threaded ends, nuts, joints, etc. Also protects against vibration, wear and impact. **WARNING! Avoid eye contact. Avoid excessive skin contact. Keep out of reach of children.**



USE ANTI-SEIZING GREASE (white tube); Prevents seizing, corrosion and excessive wear between the titanium components of your exhaust system. **WARNING! Avoid eye contact. Avoid excessive skin contact. Keep out of reach of children.**

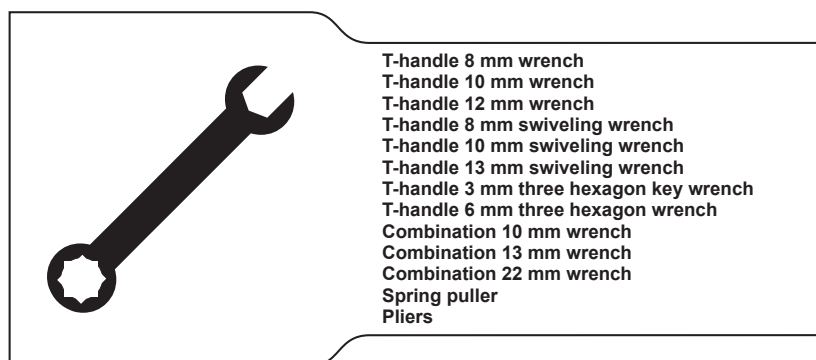

BEFORE INSTALLING, CHECK SCHEMATIC OF THE EXHAUST SYSTEM!



IF ANY ITEMS IN THE AKRAPOVIČ EXHAUST SYSTEM PACKAGE ARE MISSING, PLEASE CONTACT YOUR AUTHORIZED DEALER. KEEP THE SCHEMATIC FOR FUTURE REFERENCE.



THESE INSTALLATION INSTRUCTIONS MUST BE READ CAREFULLY IN ORDER TO ENSURE PROPER INSTALLATION AND OPERATION OF THE AKRAPOVIČ EXHAUST SYSTEM.



THE EXHAUST SYSTEM CAN BE EXTREMELY HOT. ALLOW THE EXHAUST AND ENGINE TO COOL DOWN BEFORE BEGINNING INSTALLATION.



WE ADVISE YOU TO LEAVE INSTALLATION TO A QUALIFIED SERVICEMAN. IMPROPER INSTALLATION MAY RESULT IN A SHORTER LIFETIME OF THE EXHAUST SYSTEM AND/OR DAMAGE TO THE VEHICLE.

REMOVAL OF ORIGINAL EXHAUST SYSTEM:

1. Put the motorcycle on a side stand, we recommend a racing stand.
2. Unscrew the marked bolts from the muffler hanging bracket, the metal clamp at the muffler link pipe-collector connection and lower muffler bracket (**Figure 1, 2**). Remove the muffler.

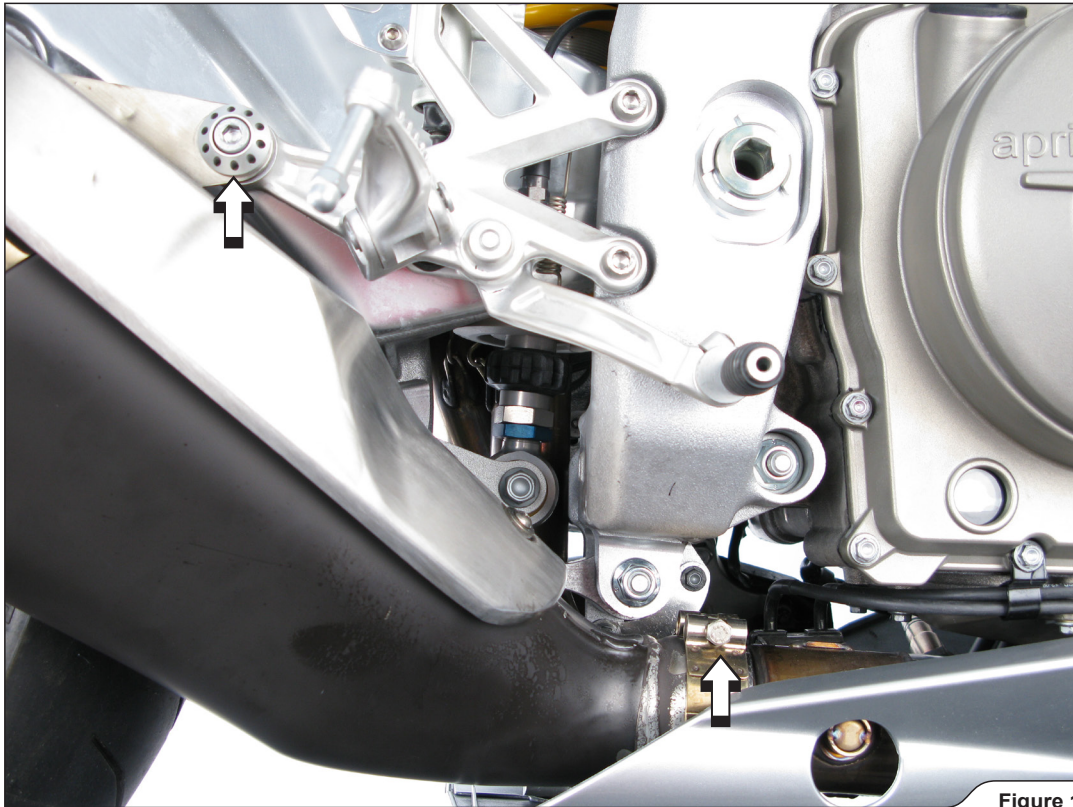

Figure 1

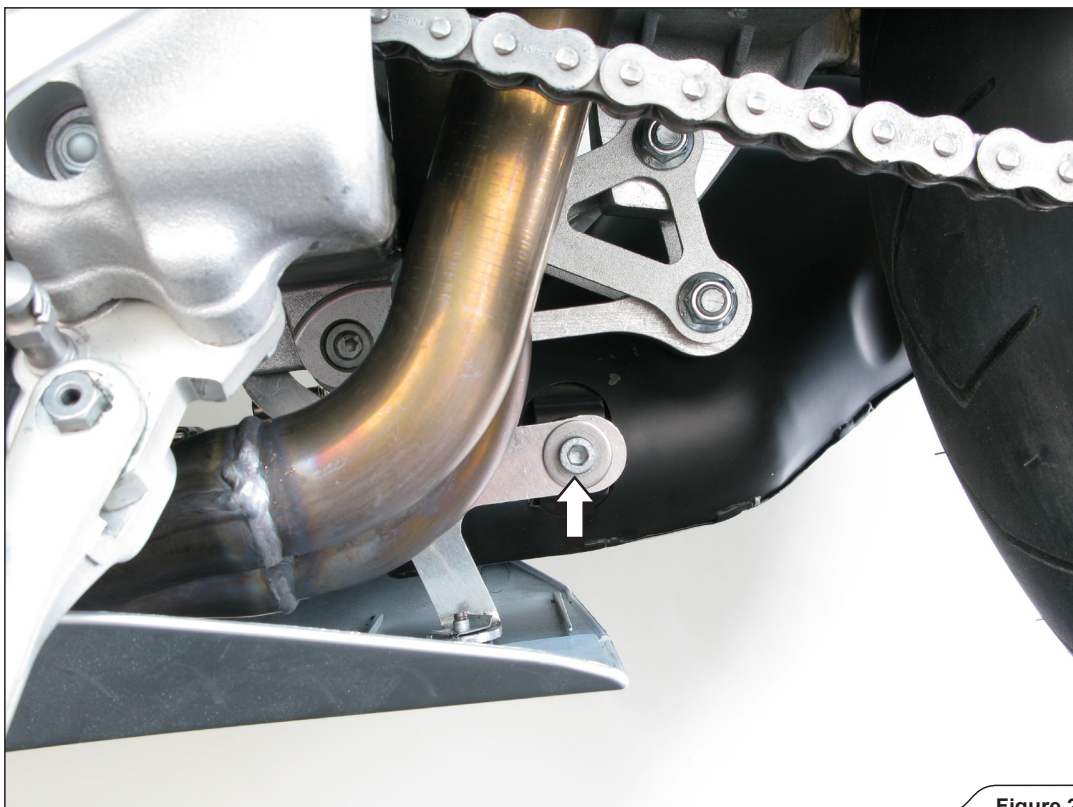

Figure 2

3. Remove the metal collar and rubber damper from the stock muffler hanging bracket (Figure 3, 4).

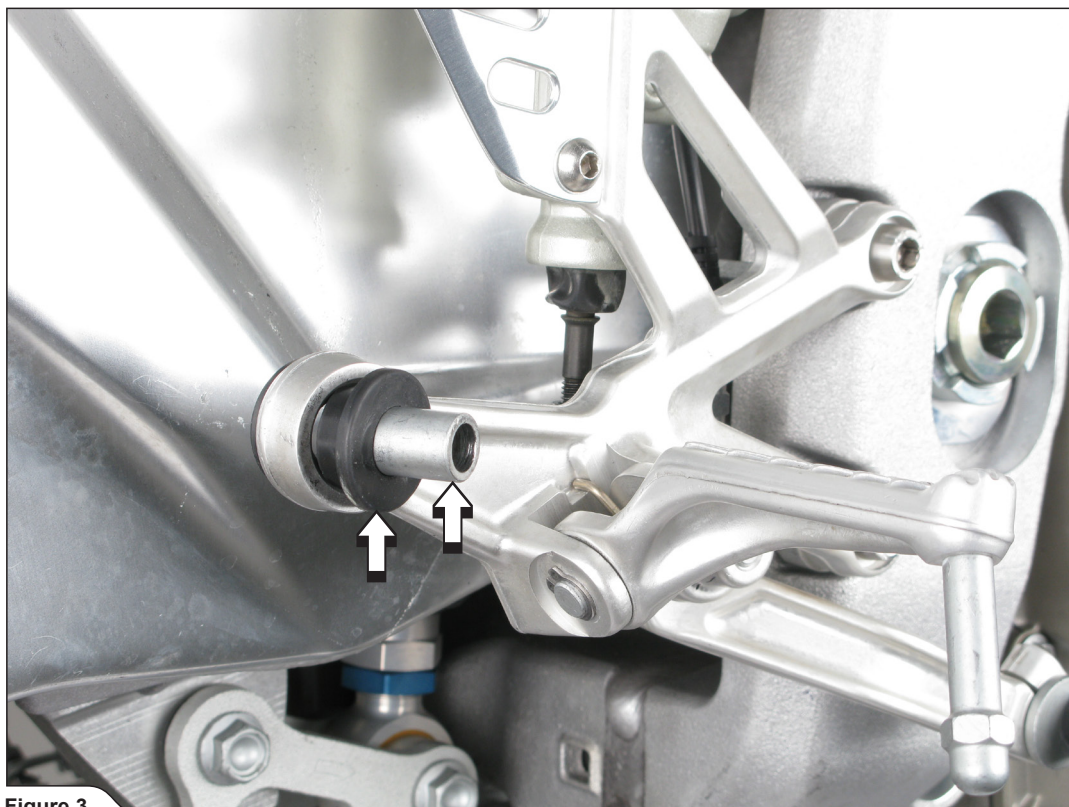

Figure 3

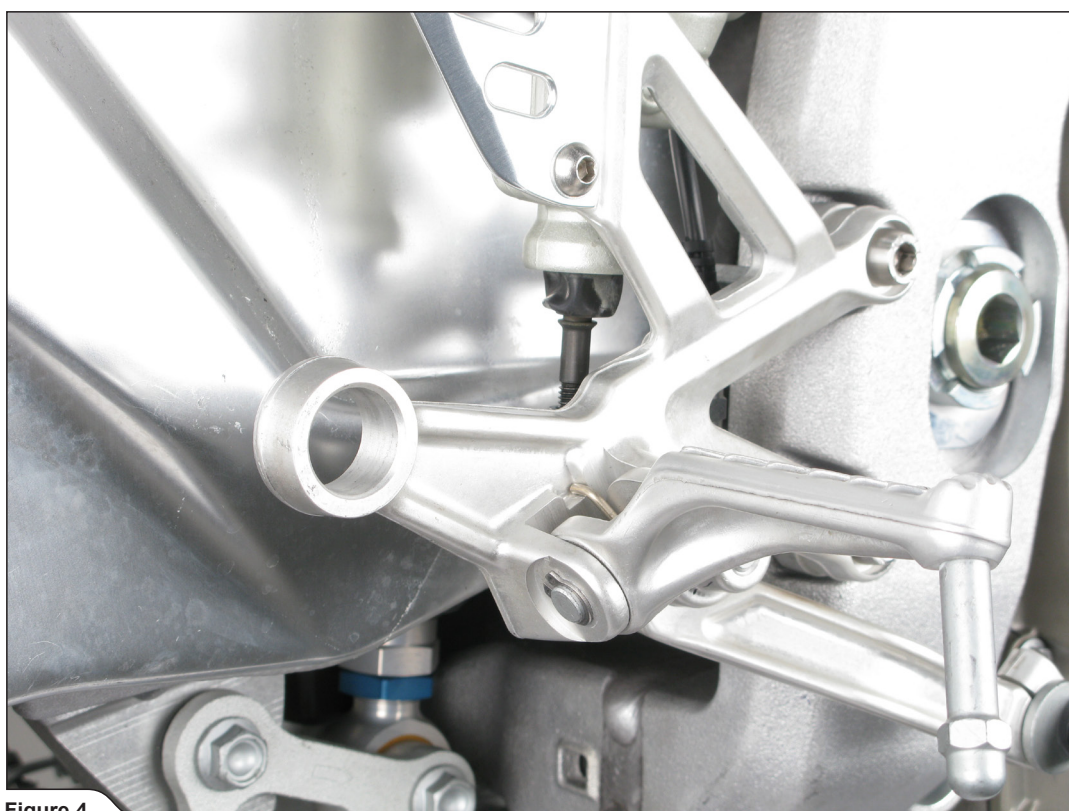
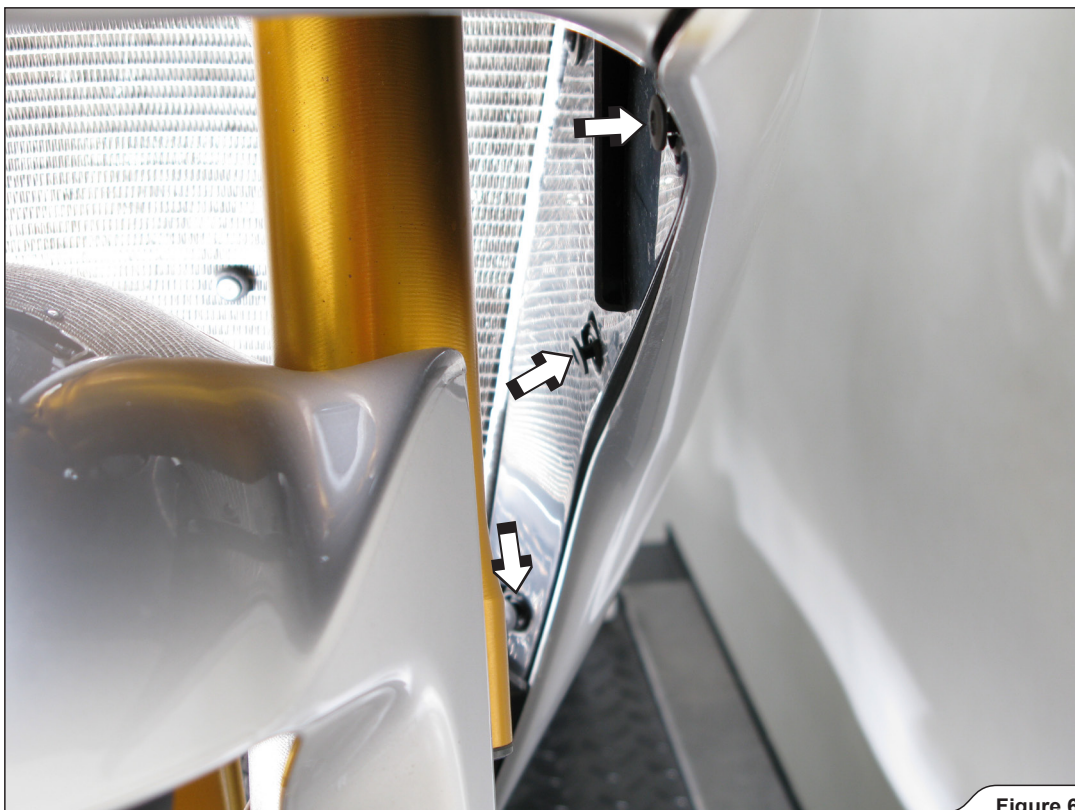
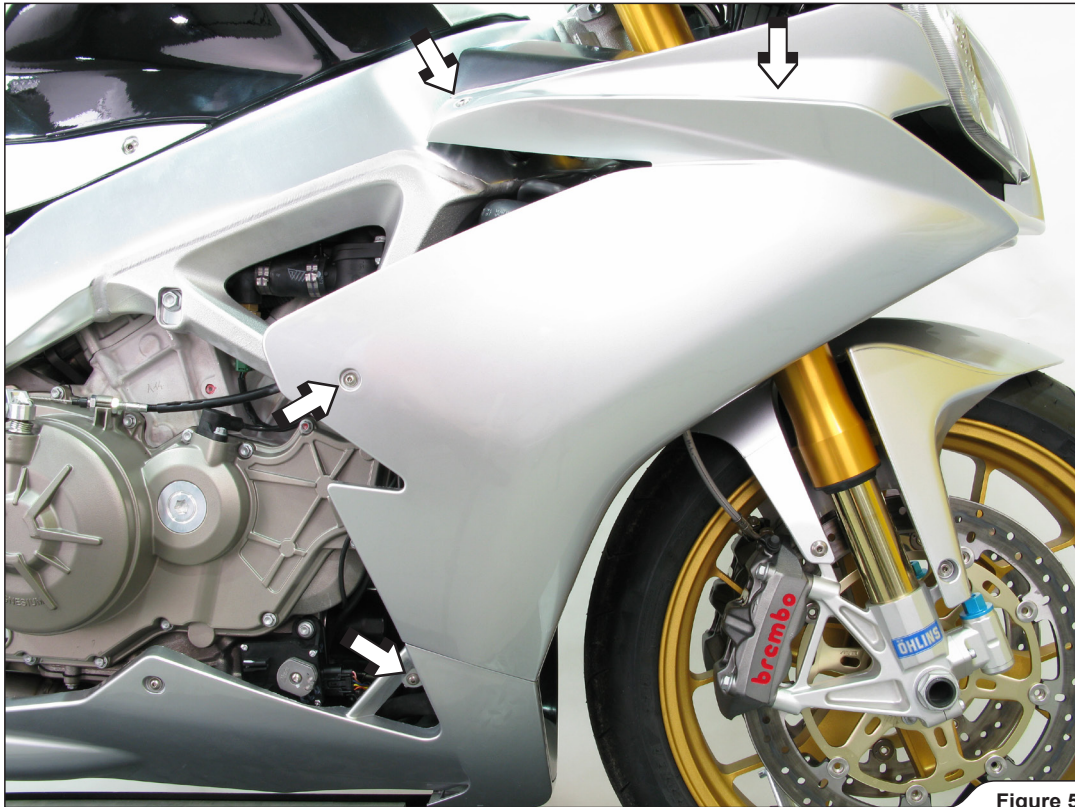

Figure 4

4. Unscrew the marked bolts and remove the plastic fasteners from the left and right side of the cowling (Figure 5, 6)



5. Unscrew the marked bolts and remove the lower part of the cowling (Figure 7, 8).

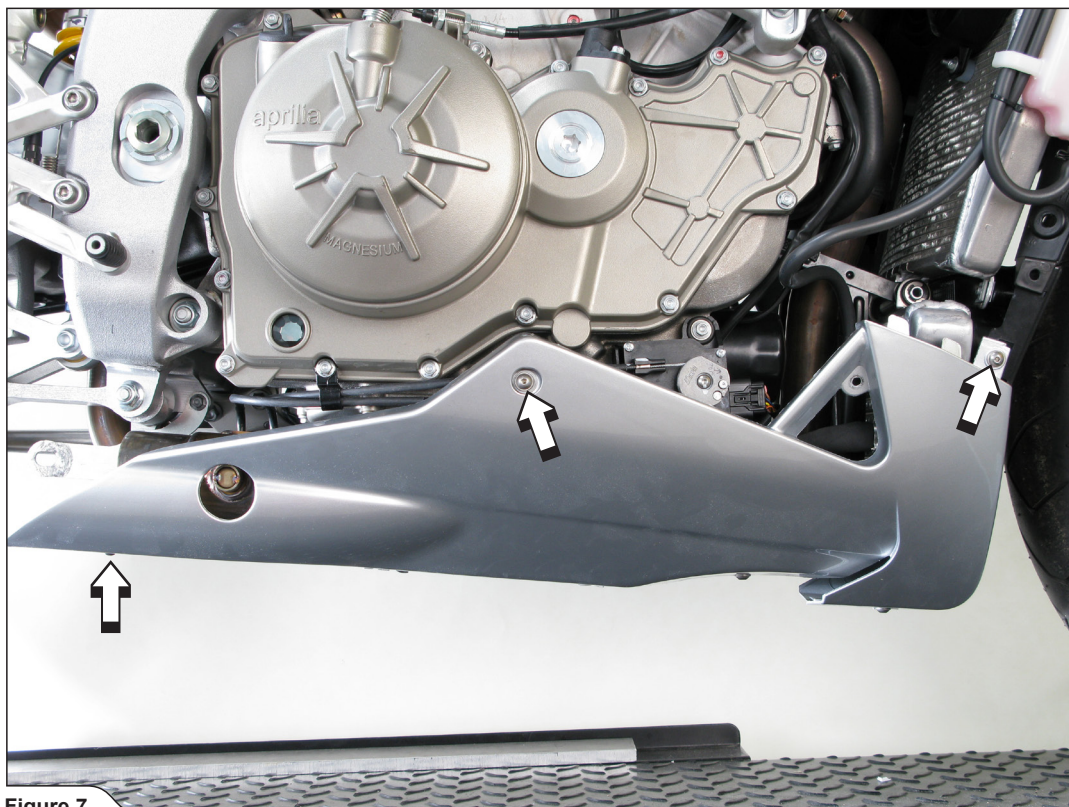

Figure 7



Figure 8

6. Unscrew the bolt, remove the stock servo motor wheel and unhook the cables of the exhaust valve (Figure 9).
! WARNING: do not turn the the servo motor wheel with force or the servo motor could be damaged. Hold the servo wheel in place with pliers when unscrewing!
✂ INSTALLATION TIP: for easier removal, loosen up the exhaust valve cable adjusters.



Figure 9

7. Reattach the servo motor wheel and tighten the bolt (Figure 10).
! WARNING: do not disconnect or remove the servo motor!

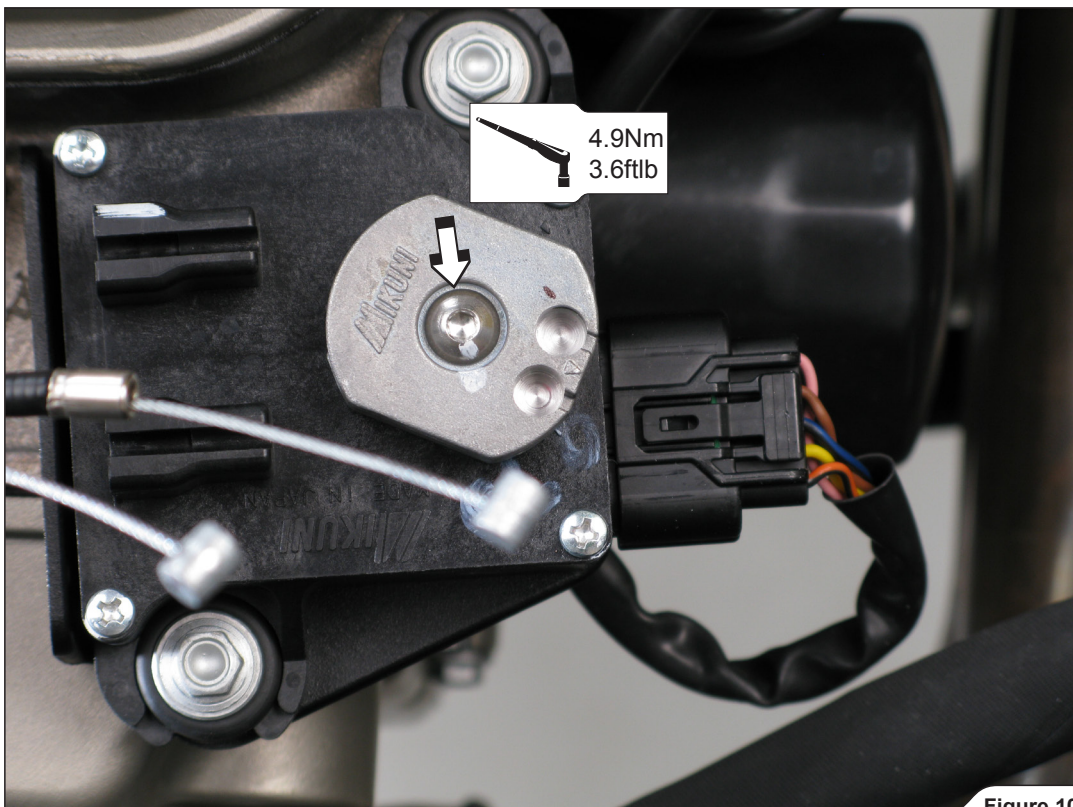
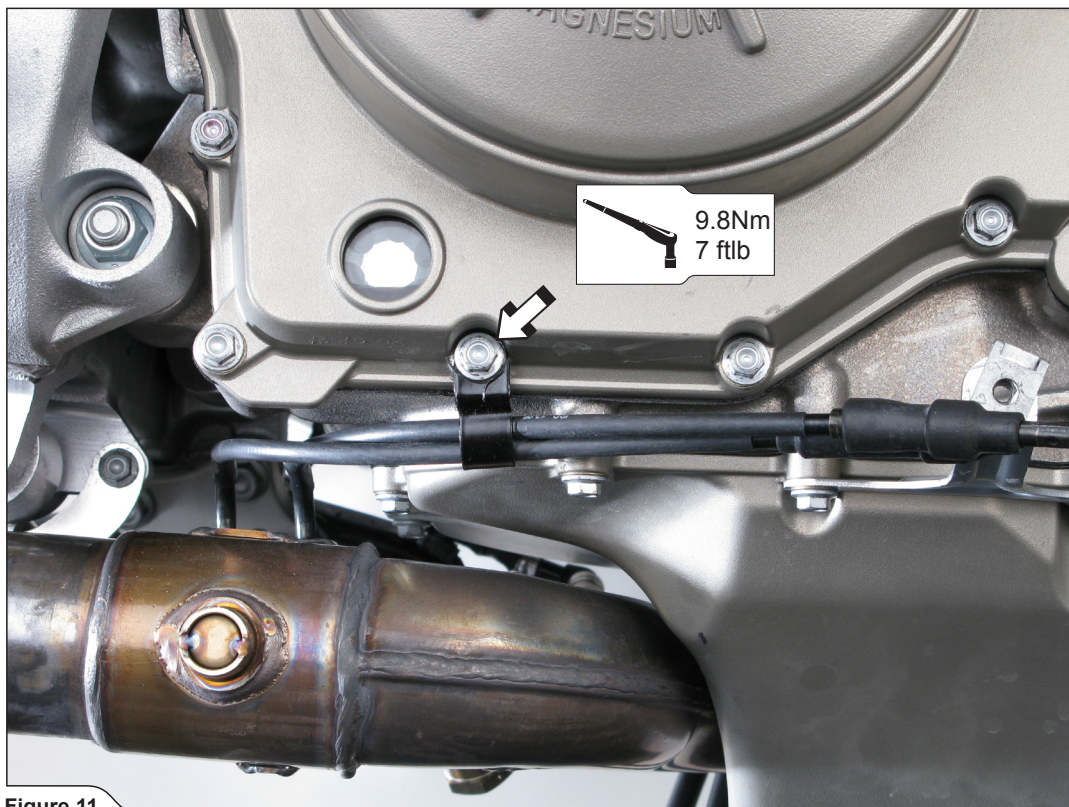

Figure 10

8. Unscrew the marked bolt and remove the bracket of exhaust valve cables. Reattach the marked bolt with tightening torque 9,8Nm / 7 ftlb (Figure 11).



9. Unscrew the bolt and remove the safety pin from the oil cooler hanging brackets and slightly move the cooler (Figure 12).
- ! **WARNING:** do not disconnect the cooling system tubes!



10. Unscrew the nuts from the front header tube flanges; make sure not to damage the radiator's cooling fins (**Figure 13**).

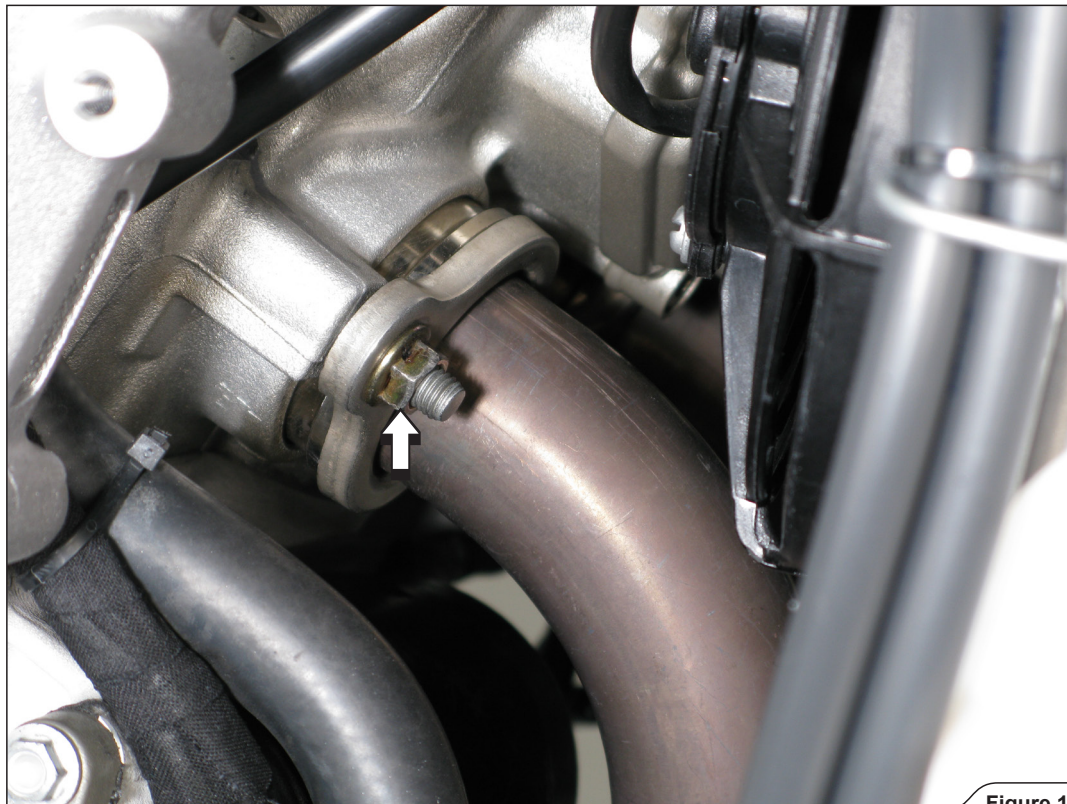

Figure 13

11. Unhook the springs (**Figure 14**) and loosen up the nuts of the rear header tubes (**Figure 15**).

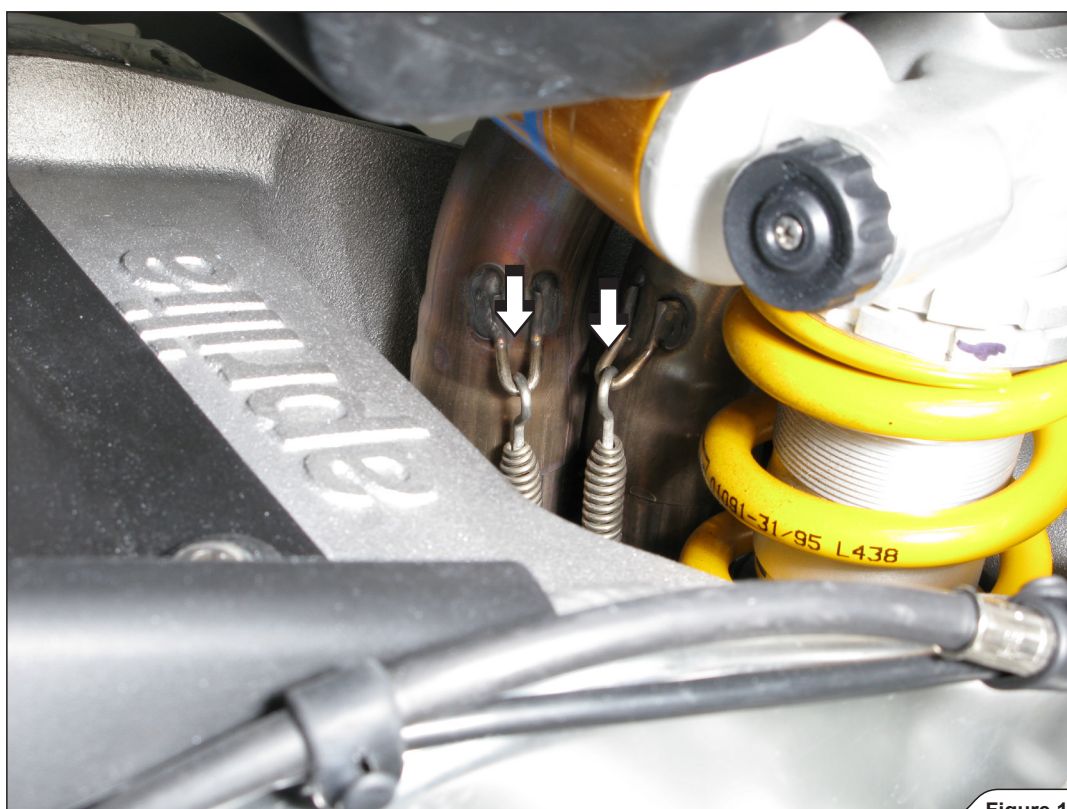

Figure 14

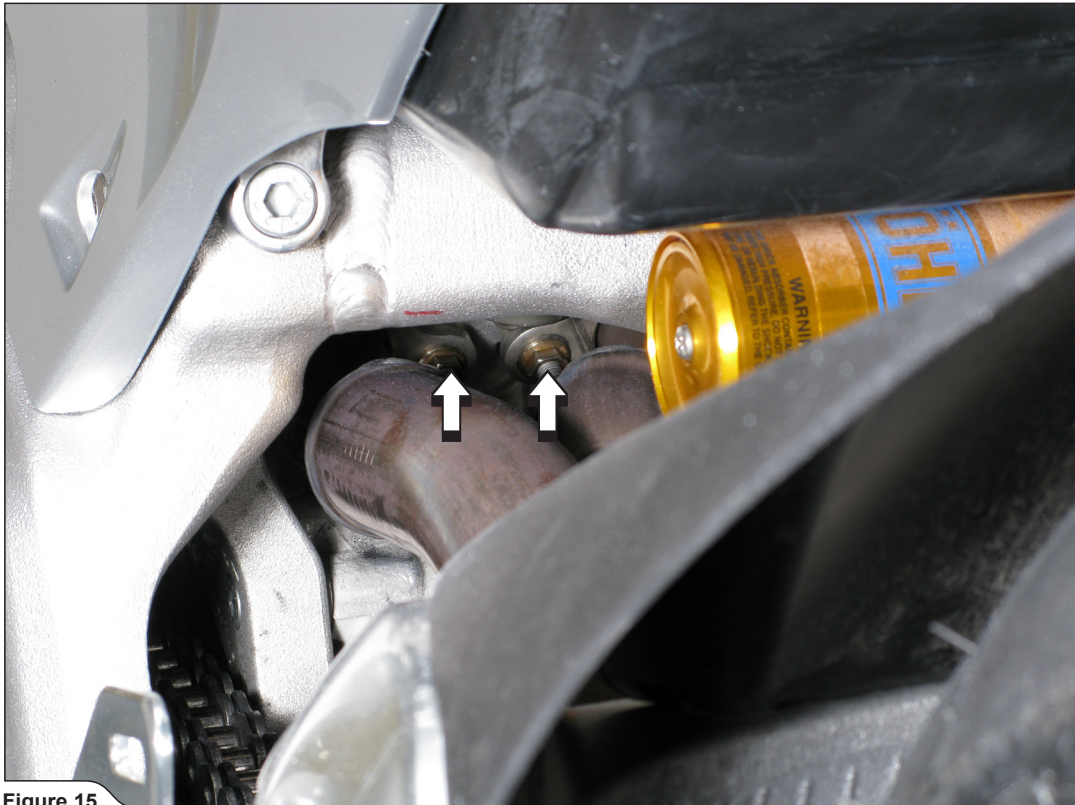

Figure 15

12. Unscrew the lambda sensor, unhook the spring and remove the collector. Unscrew the nuts of the rear header tubes and remove the rear header tubes (Figure 16).

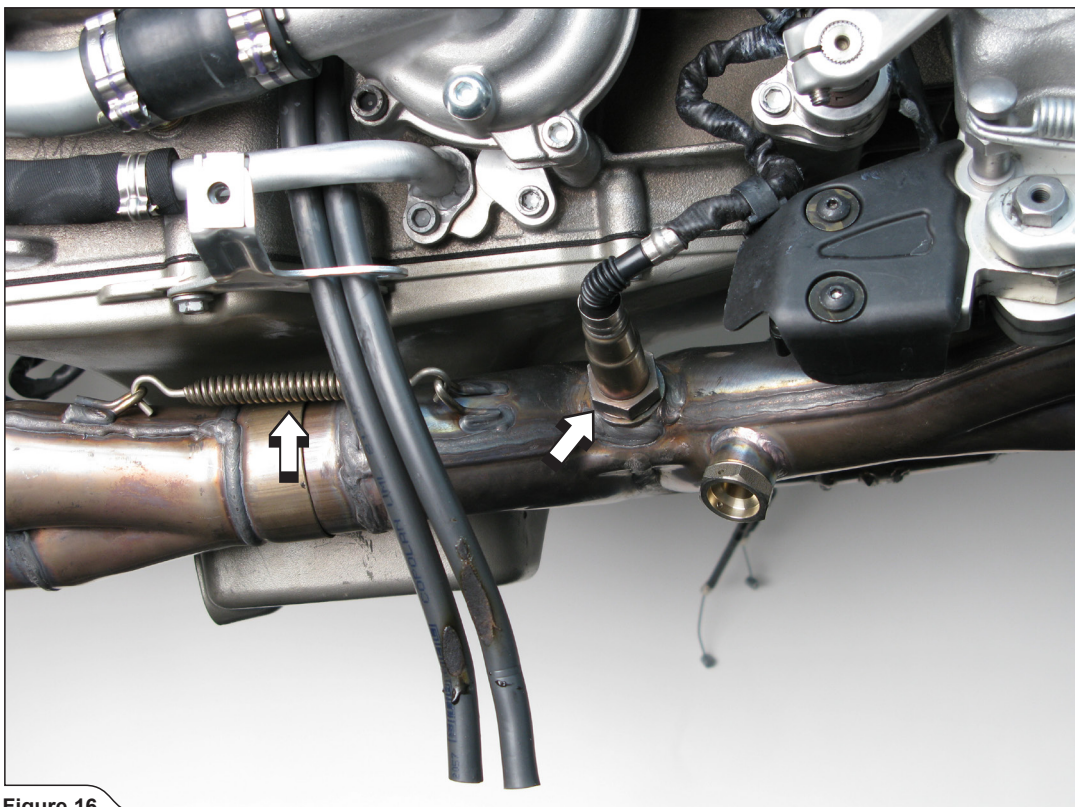

Figure 16

INSTALLATION OF THE AKRAPOVIČ RACING OR EVOLUTION EXHAUST SYSTEMS:

1. Set up the sleeves together with the flanges and springs; make sure they are correctly oriented and that the holes for attaching the springs line up with the loops on the header tubes; for the **front** header tubes (**Figure 17**) and for the **rear** header tubes (**Figure 18**).



Figure 17



Figure 18

2. Tighten the nuts to a specified torque (**Figure 19, 20**).

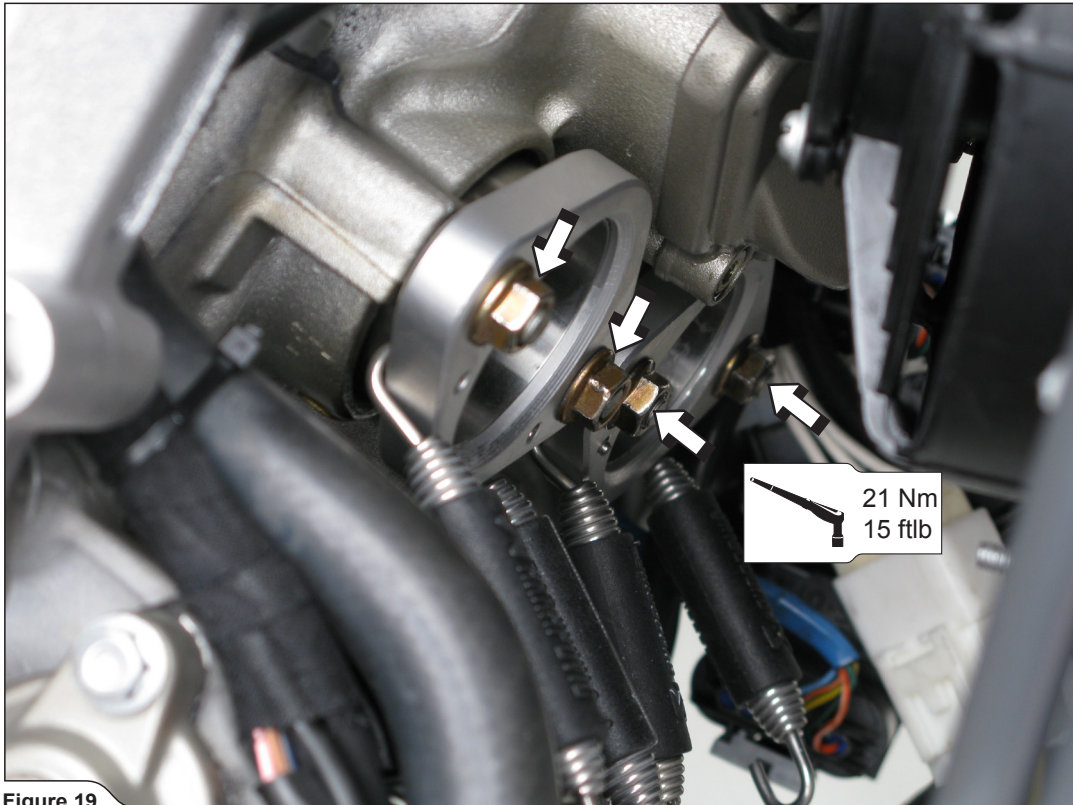

Figure 19

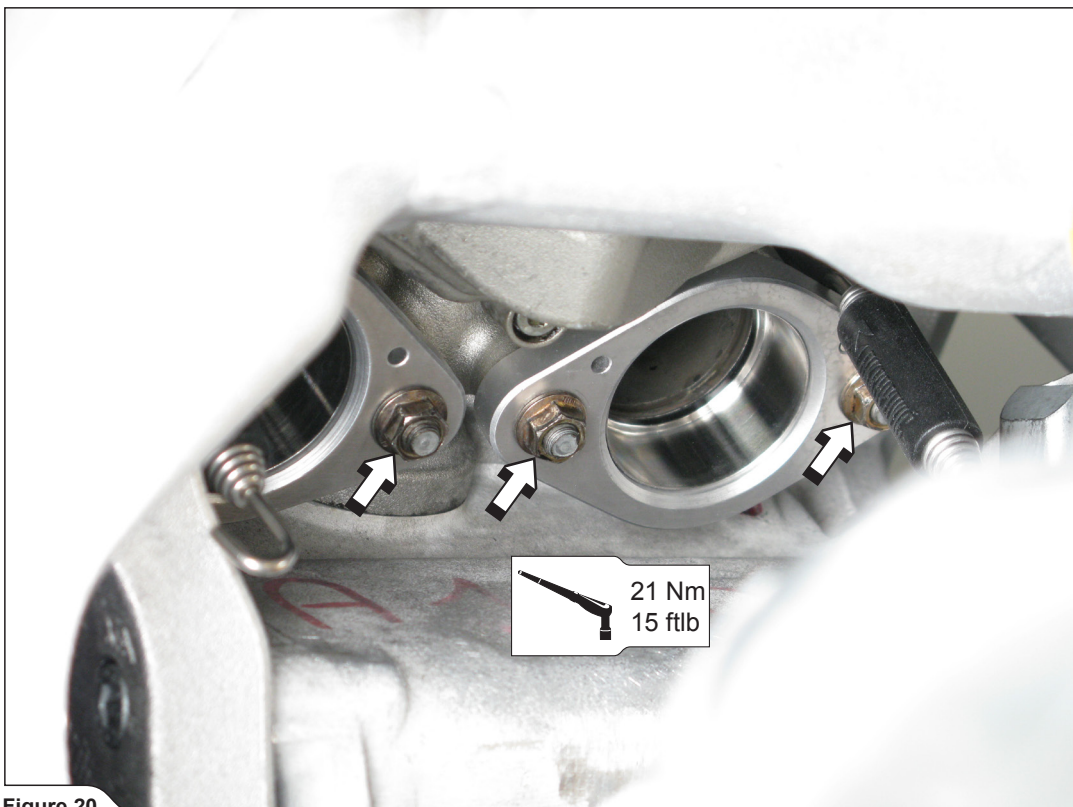

Figure 20

3. Insert the front and rear header tubes properly (Figure 21).

✂ **INSTALLATION TIP:** do not attach the springs yet.

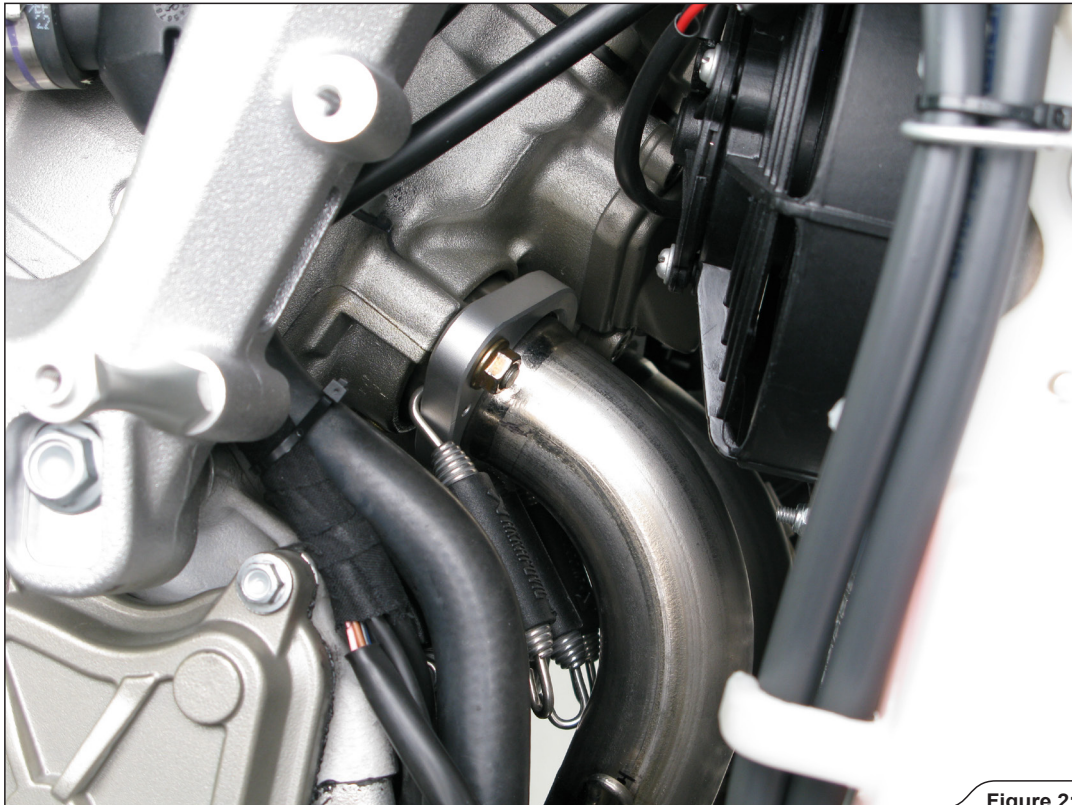

Figure 21

4. Slide the collector onto the header tubes and attach the springs (Figure 22, 23, 24).

! **WARNING:** make sure, that springs pull the collector all the way onto the headers – use rubber mallet if necessary to tap the connections into place!

✂ **INSTALLATION TIP:** for Evolution exhaust system, coat the interior side of the input bushes of the titanium collector with Akrapović ceramic anti-seizing grease(white tube).

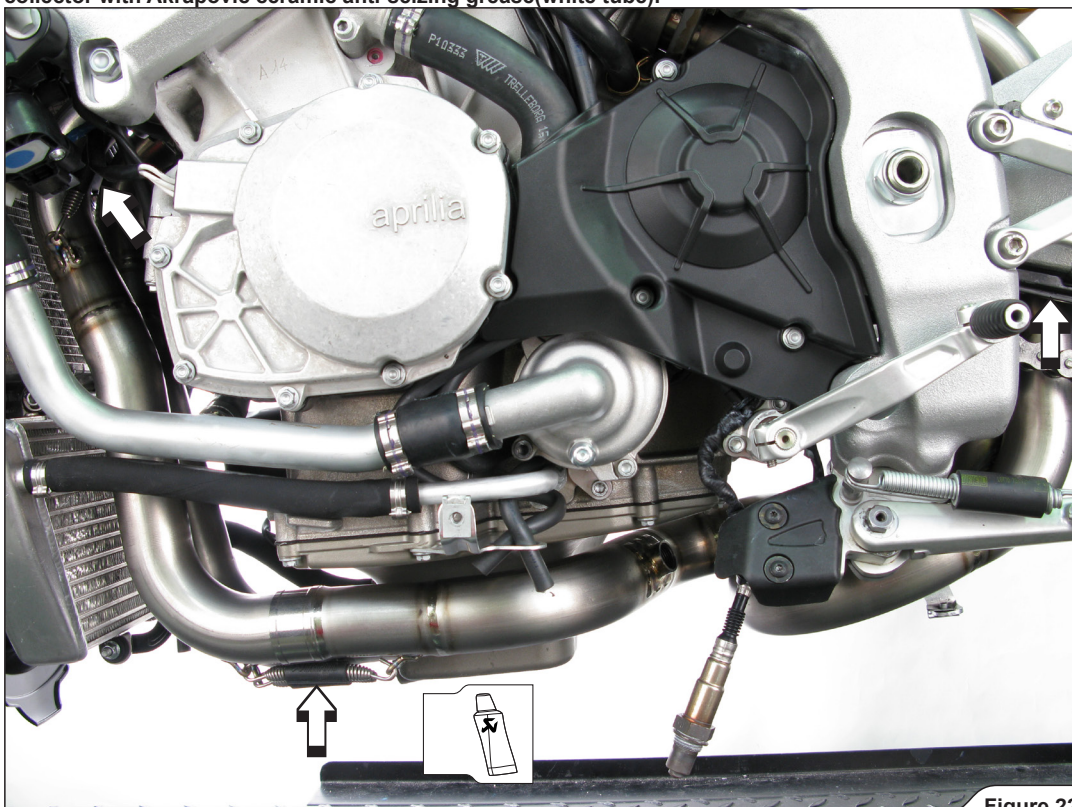

Figure 22

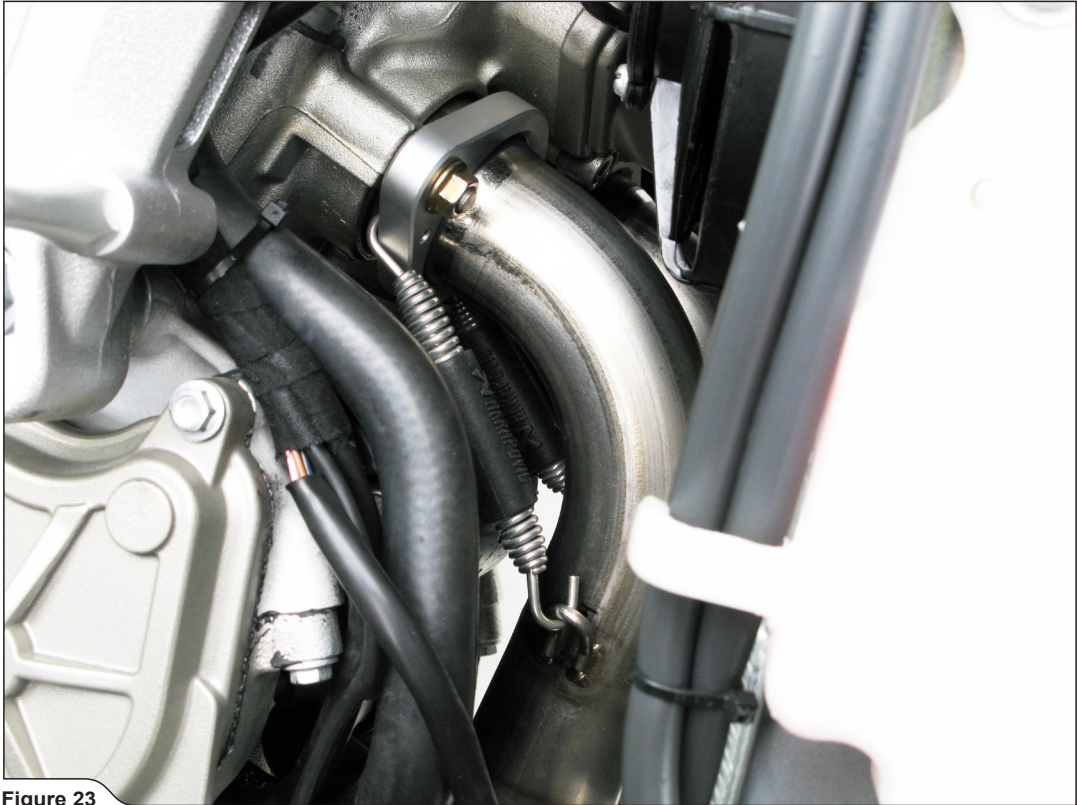

Figure 23

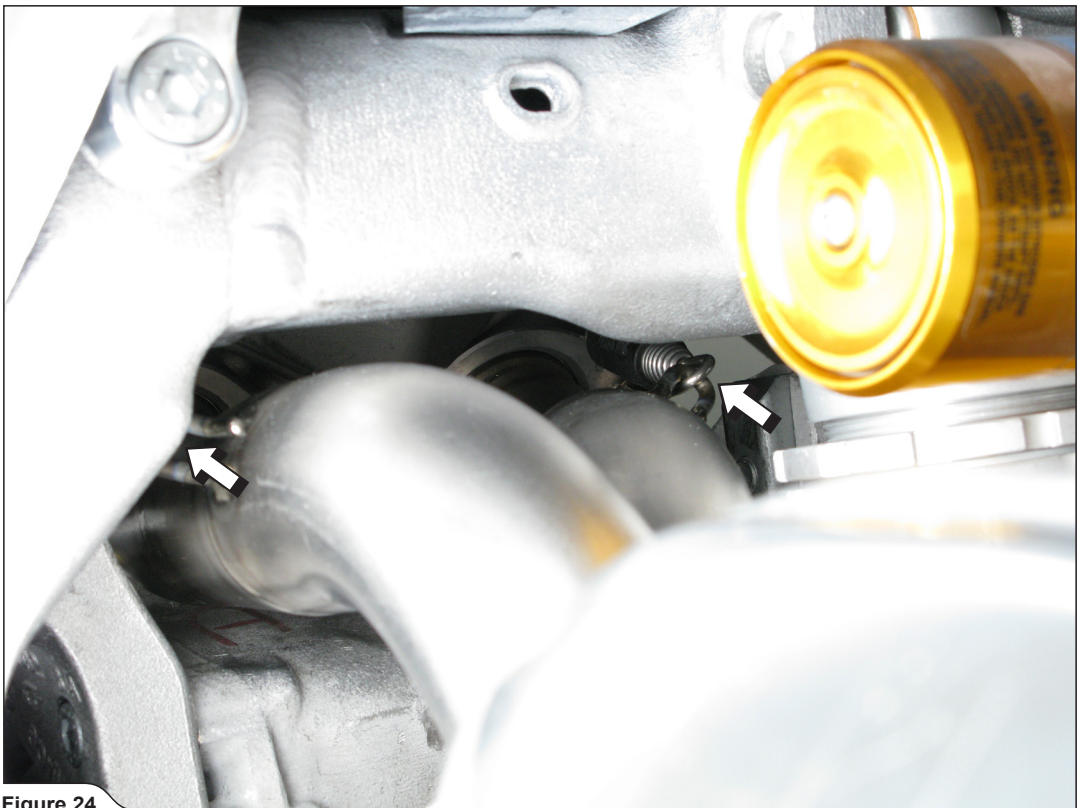
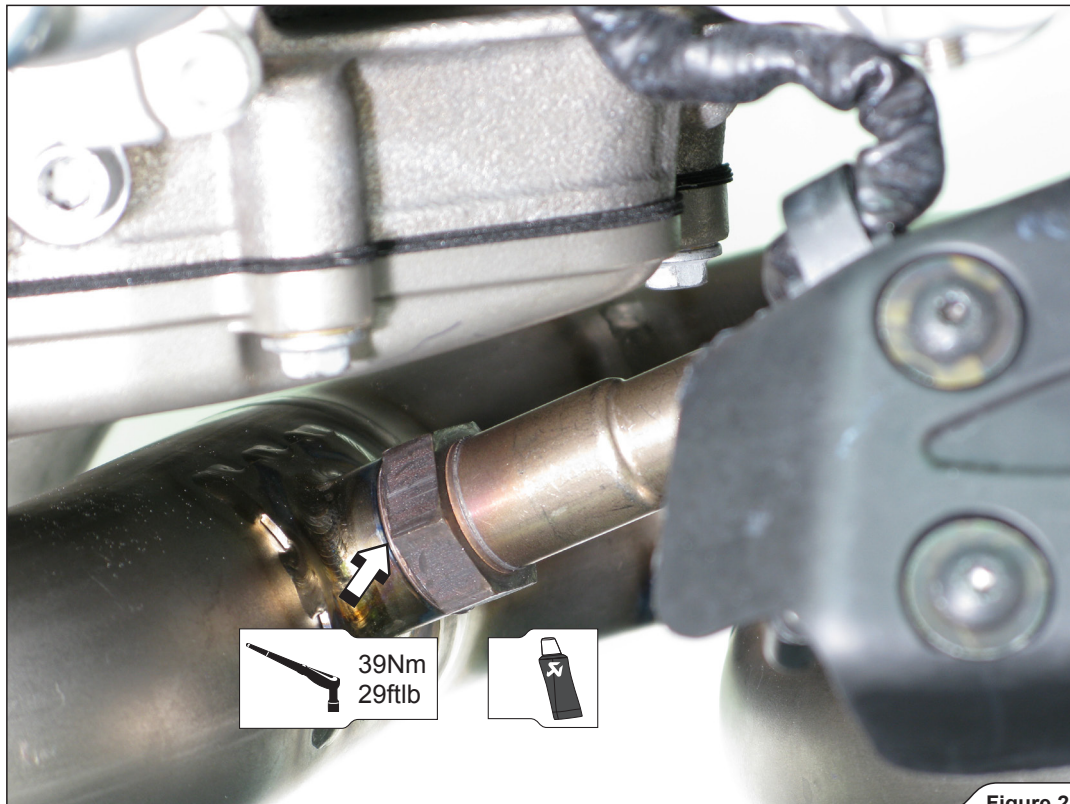

Figure 24

5. Tighten the lambda sensor; make sure not to damage the sensor's electrical lead during this process (Figure 25).
! WARNING: grease only the threads of the lambda sensor with Akrapovič anti-seize lead-free copper paste (black tube)!



6. Unscrew the marked bolts and remove the passenger's footrest (Figure 26). Assemble the Akrapovič carbon fiber muffler bracket using Akrapovič bolts, washers and aluminium distance bushes (Figure 27).



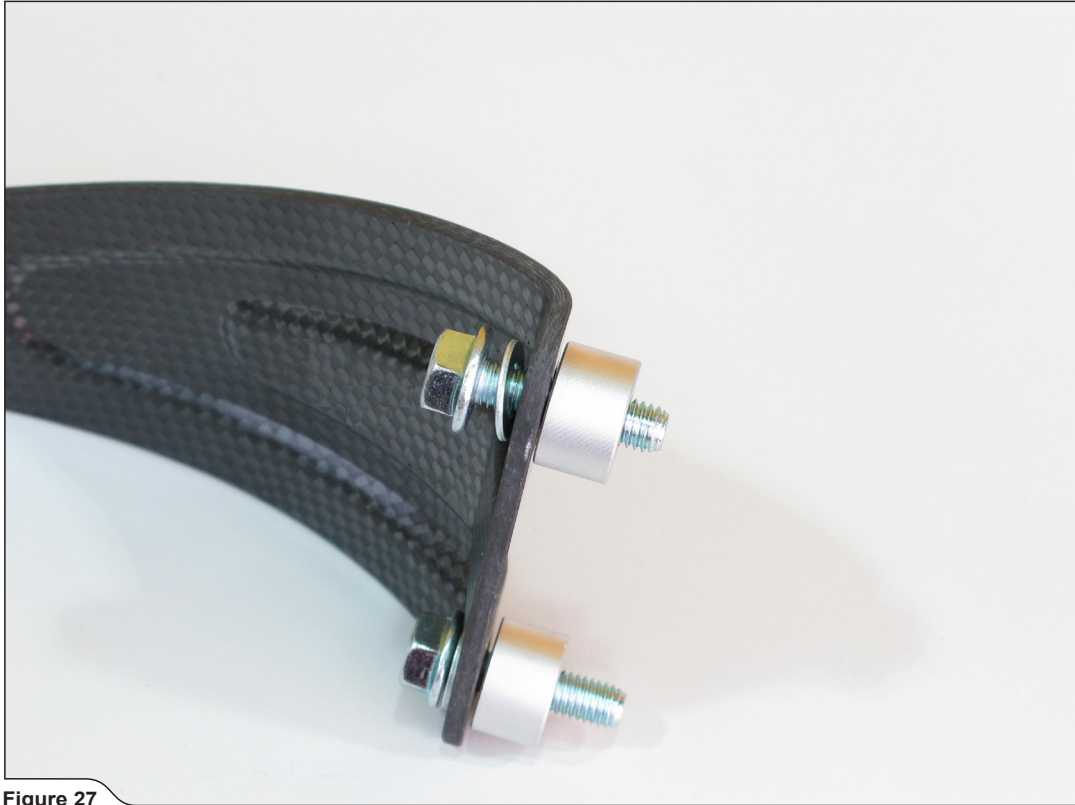

Figure 27

7. For option with passenger footrest (Evolution2 & Racing2): assemble stock passenger's footrest with the Akrapovič carbon fiber muffer bracket using Akrapovič bolts, washers and distance bushes (Figure 28).



Figure 28

8. Tighten the muffler's bracket onto the subframe (Figure 29).

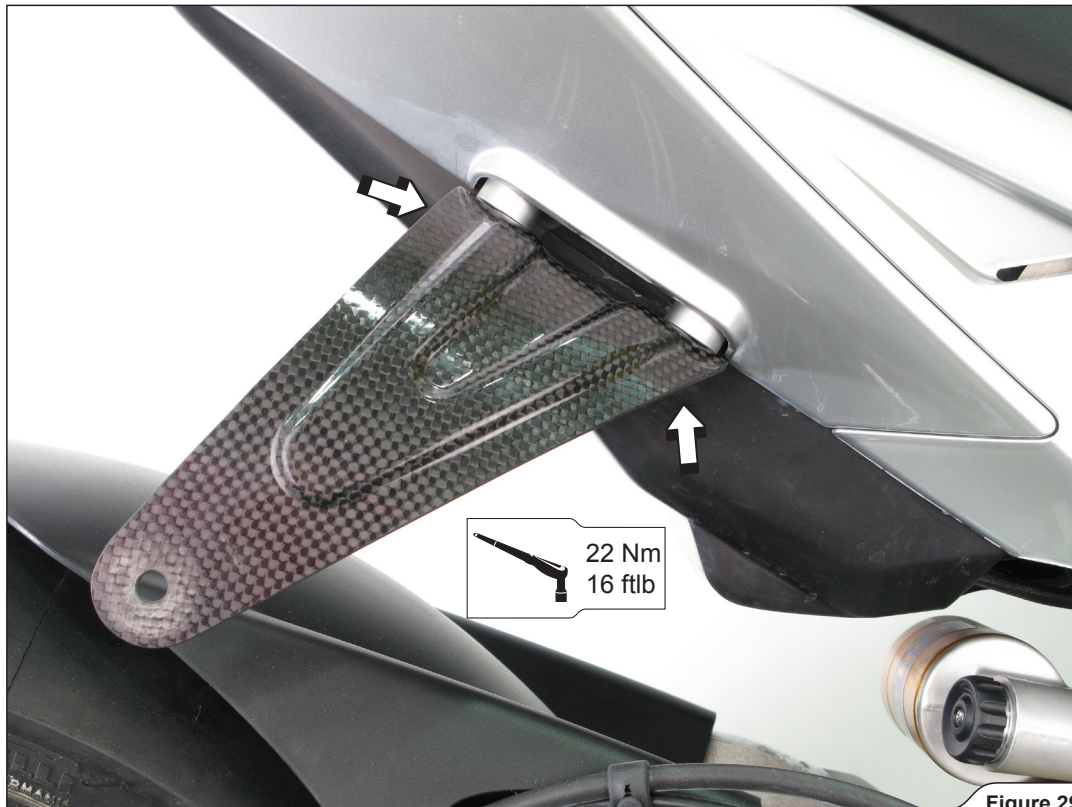

Figure 29

9. Slide the link pipe onto the collector and attach the springs (Figure 30).

! **WARNING:** make sure, that springs pull the link pipe all the way onto the collector – use rubber mallet if necessary to tap the connection into place!

✂ **INSTALLATION TIP:** for Evolution exhaust system, coat the interior side of the input bushes of the titanium link pipe with Akrapović ceramic anti-seizing grease (white tube).

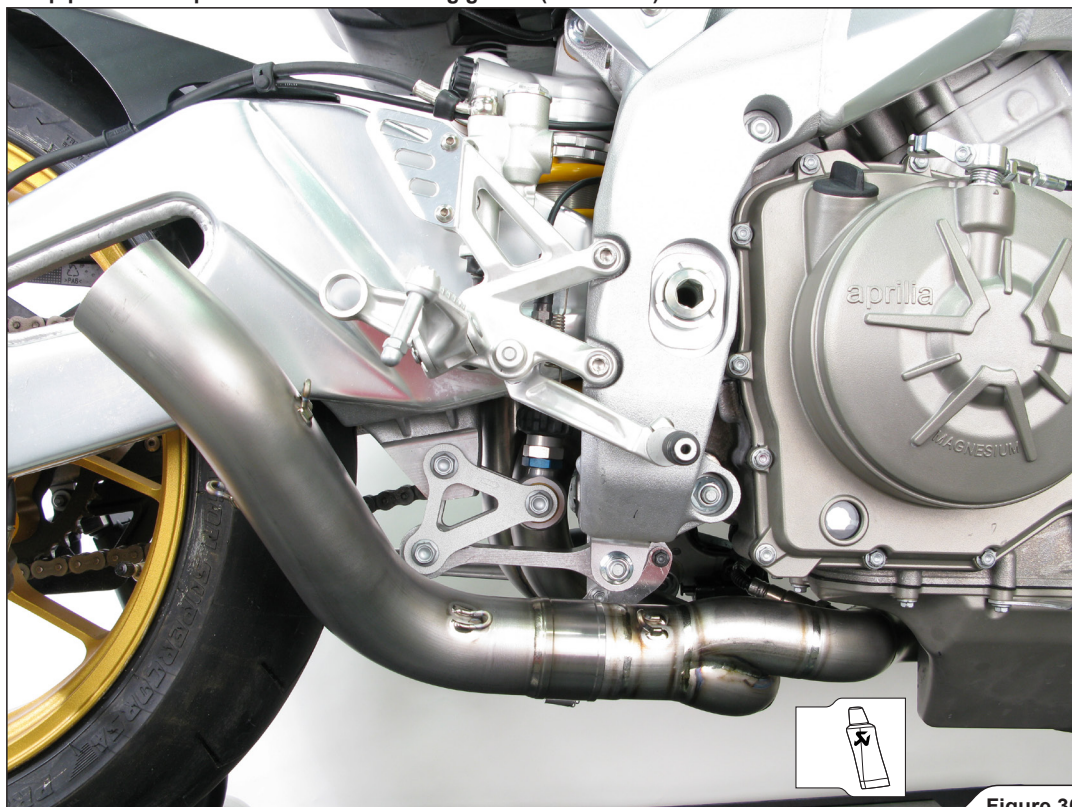

Figure 30

10. Correctly position the carbon-fiber clamp and slide it onto the muffler - bear in mind the **left offset** of the carbon fiber- clamp viewed from the rear (**Figure 31**).

! **WARNING:** open the clamp slightly wider than the diameter of the outer sleeve of the muffler – do not scrape it along the muffler outer sleeve!



Figure 31

11. Position the muffler correctly and slide it onto the outlet side of the link pipe. Attach the springs (**Figure 32**).

! **WARNING:** make sure, that springs pull the muffler all the way onto the link pipe – use rubber mallet if necessary to tap the connection into place!

✂ **INSTALLATION TIP:** for Evolution exhaust system, coat the interior side of the input bush of the muffler with Akrapovič ceramic anti-seizing grease (white tube).



Figure 32

- Align the muffler in respect to the motorcycle and tighten the muffler clamp using Akrapovič bolt, washer and aluminium distance bush with stock spacer bush and nut as shown (Figure 33).

✂ INSTALLATION TIP: place the aluminium distance bush so that the larger radius is on the carbon fiber muffler bracket.

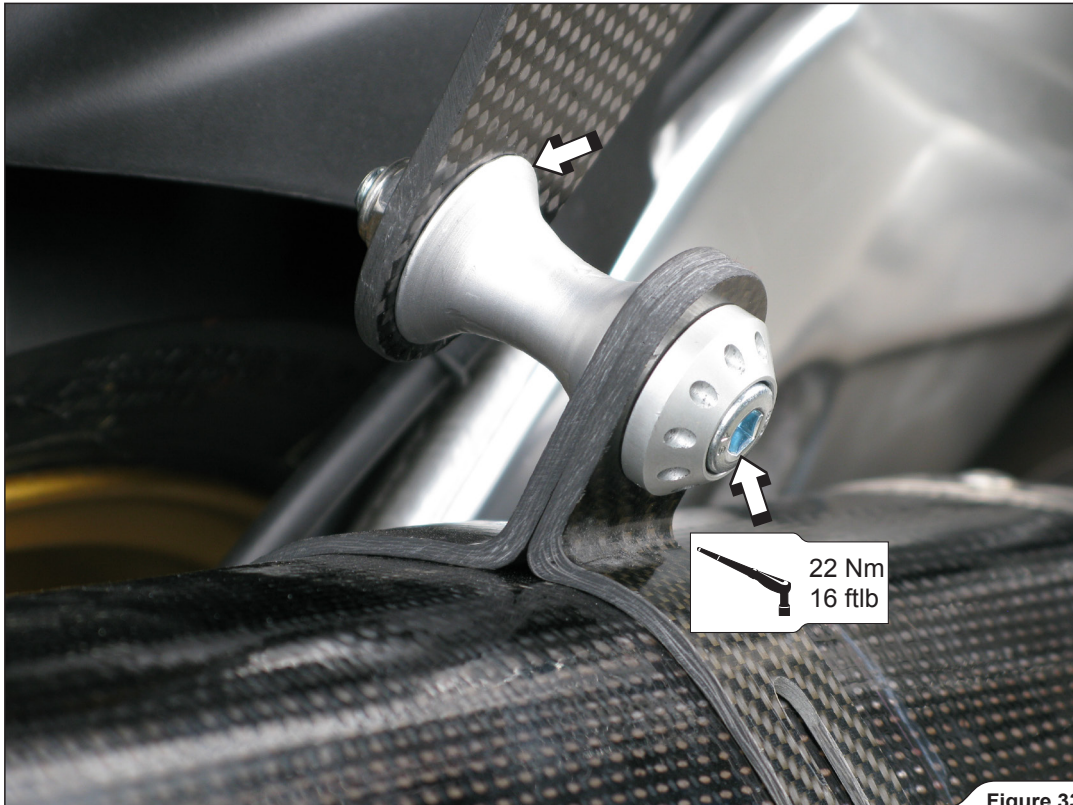

Figure 33

- Attach the oil cooler in the reverse order from the order in which it was removed (Figure 34).

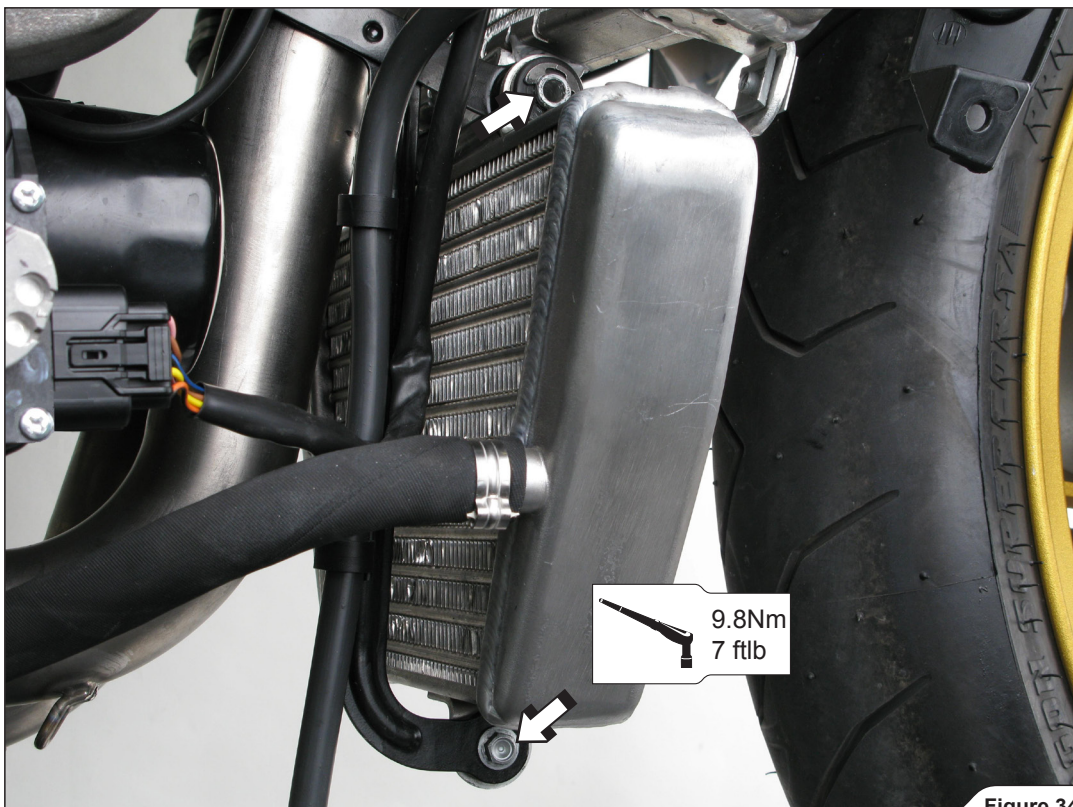

Figure 34

14. Attach the cowlings in the reverse order from the order in which they were removed (Figure 35, 36).

! **WARNING:** because of the risk of melting or fire, the drain pipes must be correctly attached to the cowling (Figure 35)! Make sure, that drain pipes doesn't touch the exhaust pipe!

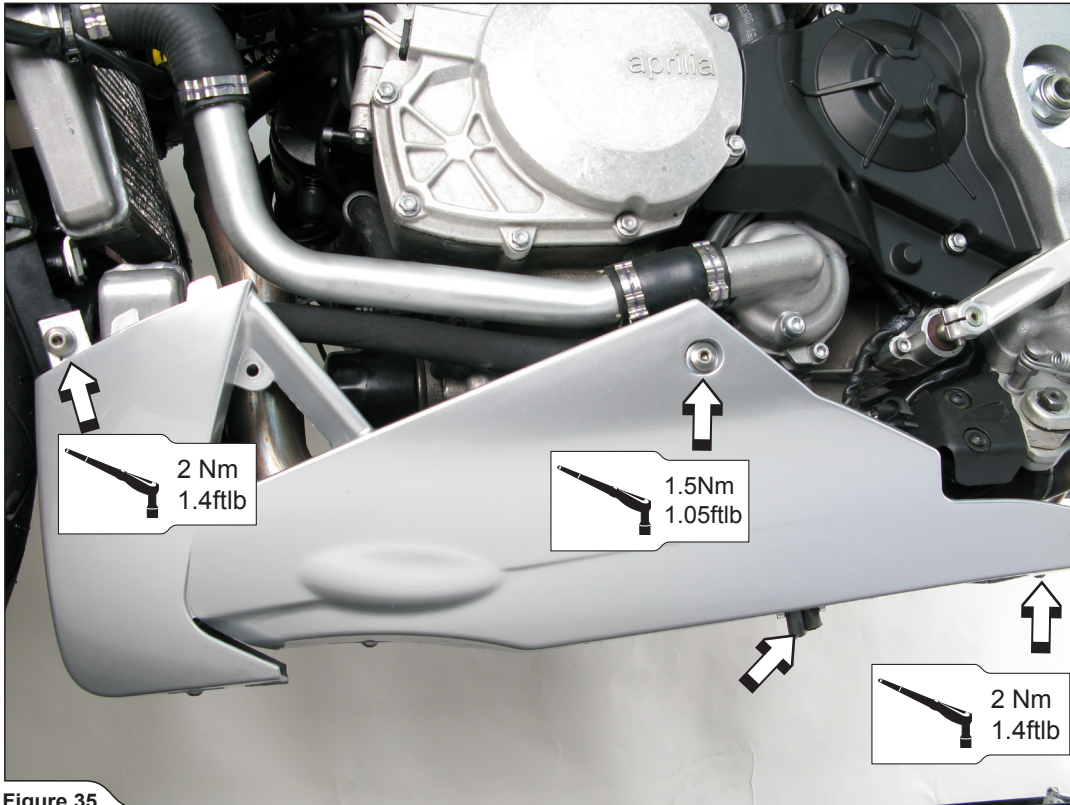

Figure 35

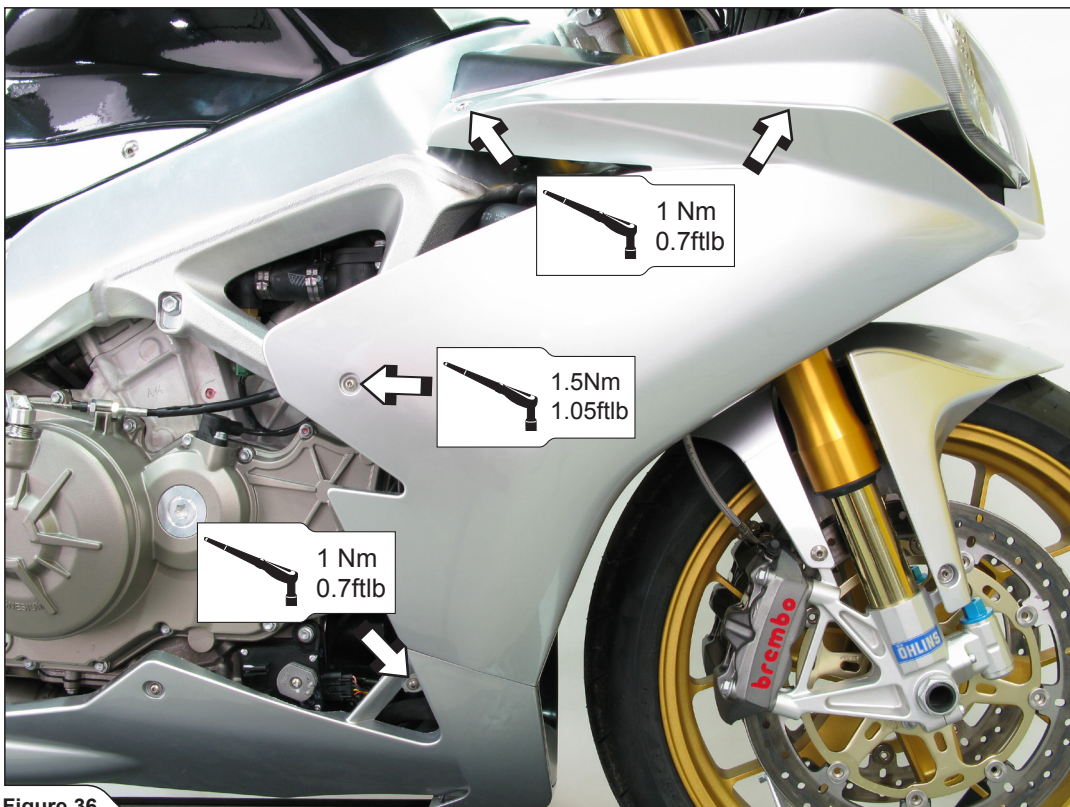

Figure 36

Final installation:

Clean grease spots:

- a. Muffler – carbon-fiber outer sleeve: use a soft dry cloth.
- b. Muffler – titanium outer sleeve: use a soft cloth sprayed with a multi-purpose spray lubricant (WD-40 or equivalent).
- c. Muffler – carbon-fiber outlet cap: use a soft dry cloth.
- d. RACING - stainless steel link pipe, collectors and header tubes: use a soft cloth sprayed with a contact cleaner, then wipe with a soft dry cloth
- e. EVOLUTION - titanium link pipe, collectors and header tubes : use a soft cloth sprayed with a multi-purpose spray lubricant (WD-40 or equivalent).

Cleaning will prevent spots from burning onto the surface. Do not use aggressive chemical cleaners, because they can damage the sticker.

! WARNING: make sure all the bolts are sufficiently tightened. In case the exhaust system touches the cowling or other parts repeat the adjustment of the exhaust system or contact your authorized dealer.

! WARNING: check vehicle manufacturer manual for tightening torques (for dismantled stock parts)!

! IT IS NORMAL IF WHITE SMOKE COMES OUT OF THE MUFFLER ON FIRST OPERATION.

! DO NOT STAND BEHIND THE MUFFLER ON FIRST OPERATION.

! DO NOT USE AUTOMOTIVE WHEEL CLEANERS OR ANY CLEANING PRODUCTS WHICH CONTAIN ACIDIC ADDITIVES TO CLEAN AKRAPOVIČ EXHAUST SYSTEMS.

MAINTENANCE OF THE AKRAPOVIČ EXHAUST SYSTEM:

1. Clean the titanium exhaust components with a multi-purpose spray lubricant (WD-40 or equivalent), carbon fiber exhaust components with soft and dry cloth and stainless steel components with soft cloth sprayed with contact cleaner, then wipe with soft and dry cloth. A change in the color of the exhaust system is normal due to the high temperatures.
2. Periodically make sure all the bolts and springs are sufficiently tight.

APRILIA RSV4, Complete exhaust system / RACING LINE / RAC 1
APRILIA TUONO V4, Complete exhaust system / RACING LINE / RAC 1
Product code: S-A10R1-ZT
S-A10R1-ZC

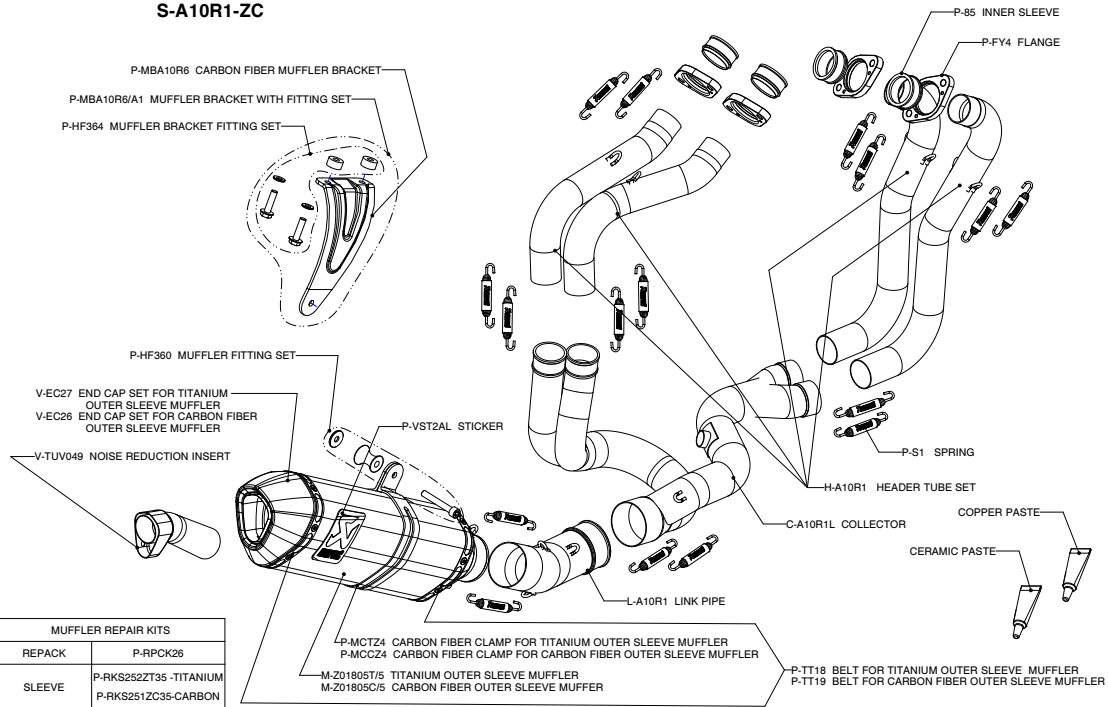

APRILIA RSV4, Complete exhaust system / EVOLUTION LINE / EVO 1
APRILIA TUONO V4, Complete exhaust system / EVOLUTION LINE / EVO 1
Product code: S-A10RFT1-ZT
S-A10RFT1-ZC

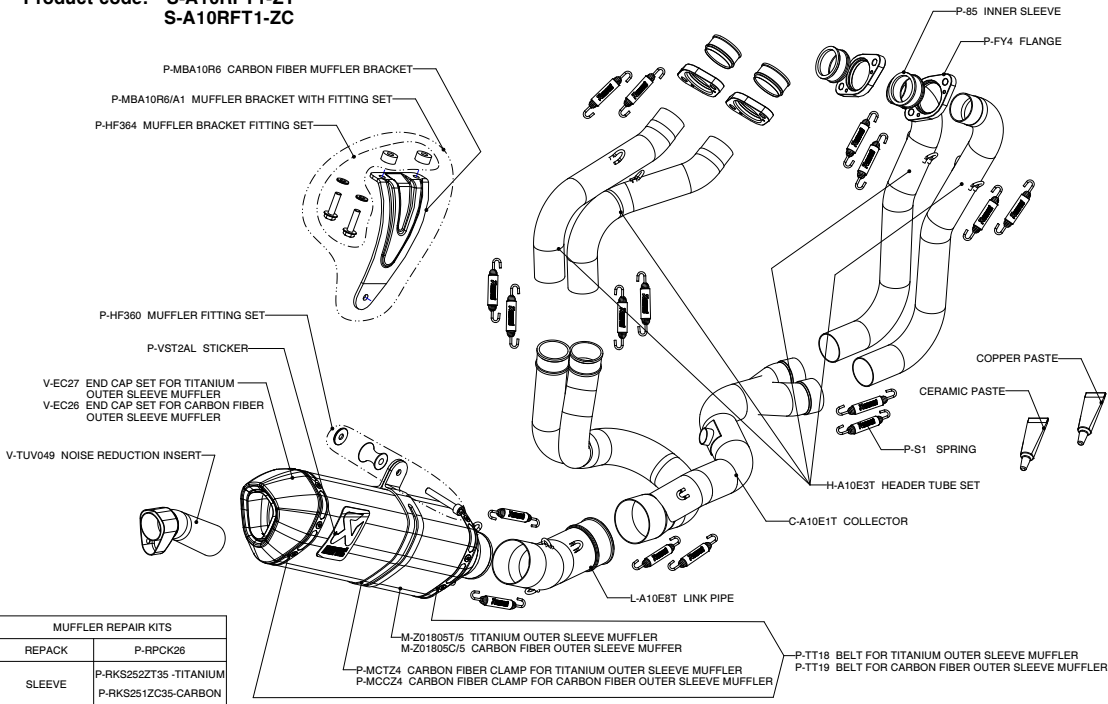

APRILIA RSV4, Complete exhaust system / RACING LINE / RAC 2
APRILIA TUONO V4, mComplete exhaust system / RACING LINE / RAC 2
Product code: S-A10R1-ZT/2
S-A10R1-ZC/2

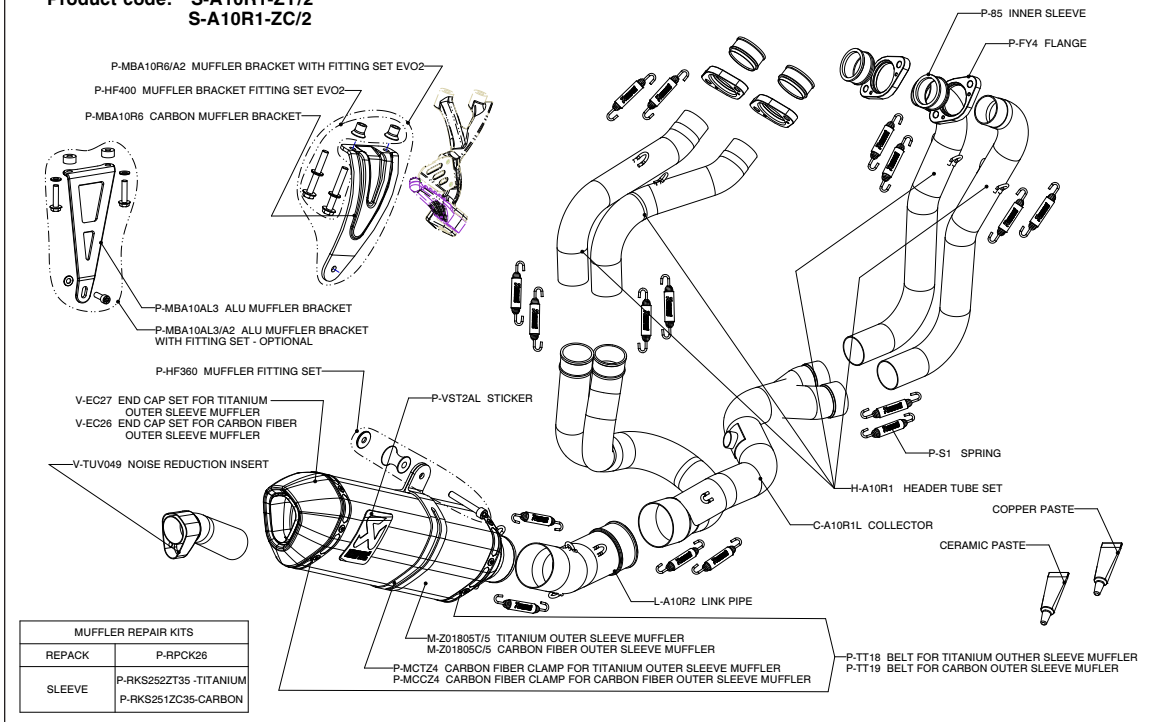

APRILLIA RSV4, Complete exhaust system / EVOLUTION LINE / EVO 2
APRILIA TUONO V4, Complete exhaust system / EVOLUTION LINE / EVO 2
Product code: S-A10RFT1-ZT/3
S-A10RFT1-ZC/3

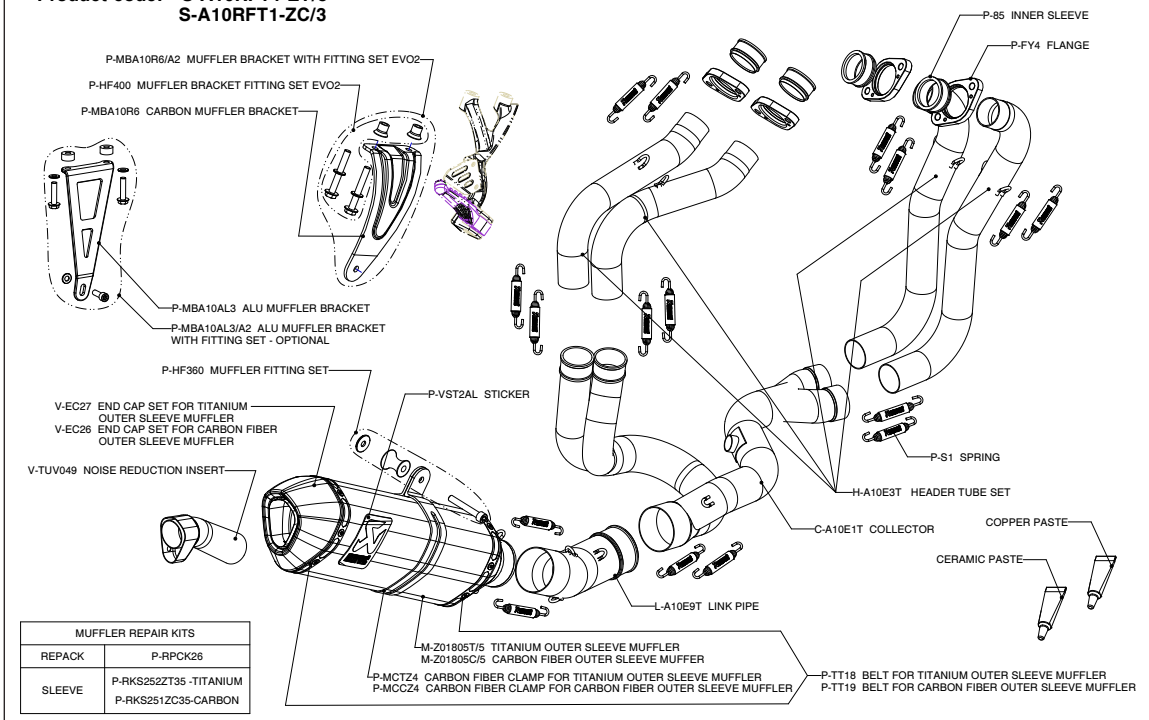

WARNING! IN CASE OF COMBINATION WITH RAC2 TUBE SET, THE SLIP-ON HOMOLOGATION IS NOT VALID!

APRILIA RSV4/ Complete exhaust system/ RAC2 TUBE SET WITH SO-HOM MUFFLER
APRILIA TUONO V4, Complete exhaust system/ RAC2 TUBE SET WITH SO-HOM MUFFLER
Product code: S-A10R1-ZT/1
S-A10R1-ZC/1

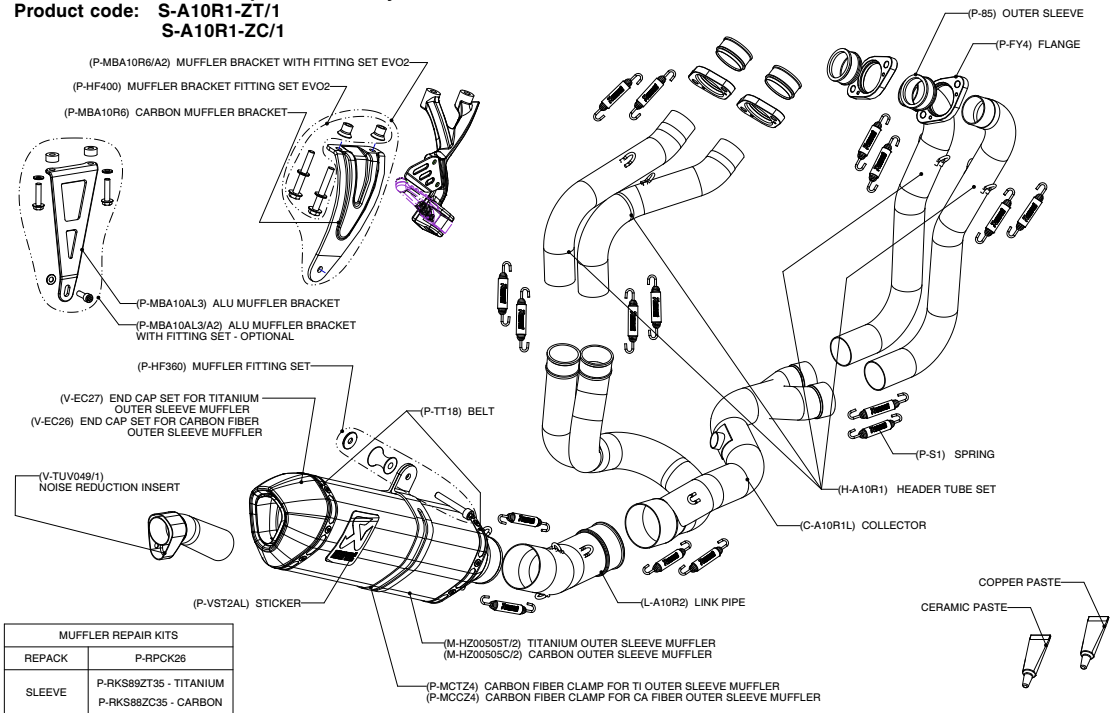

WARNING! IN CASE OF COMBINATION WITH EVO2 TUBE SET, THE SLIP-ON HOMOLOGATION IS NOT VALID!

APRILIA RSV4/ Complete exhaust system/ EVO2 TUBE SET WITH SO-HOM MUFFLER
APRILIA TUONO V4
Product code: S-A10RFT1-ZT/1
S-A10RFT1-ZC/1

